



# ***HTR-5460***

---

*Natural Sound AV Receiver*  
*Ampli-tuner audio-vidéo*

OWNER'S MANUAL  
MODE D'EMPLOI

# SAFETY INSTRUCTIONS

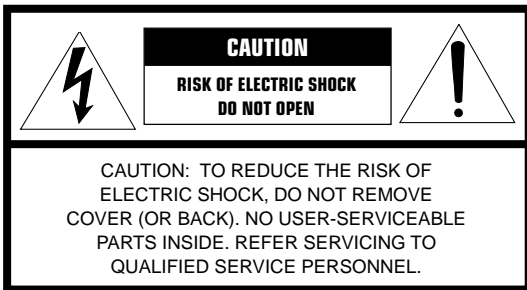

• Explanation of Graphical Symbols



The lightning flash with arrowhead symbol, within an equilateral triangle, is intended to alert you to the presence of uninsulated “dangerous voltage” within the product’s enclosure that may be of sufficient magnitude to constitute a risk of electric shock to persons.



The exclamation point within an equilateral triangle is intended to alert you to the presence of important operating and maintenance (servicing) instructions in the literature accompanying the appliance.

**WARNING**

TO REDUCE THE RISK OF FIRE OR ELECTRIC SHOCK, DO NOT EXPOSE THIS UNIT TO RAIN OR MOISTURE.

- 1 Read Instructions – All the safety and operating instructions should be read before the unit is operated.
- 2 Retain Instructions – The safety and operating instructions should be retained for future reference.
- 3 Heed Warnings – All warnings on the unit and in the operating instructions should be adhered to.
- 4 Follow Instructions – All operating and other instructions should be followed.
- 5 Water and Moisture – The unit should not be used near water – for example, near a bathtub, washbowl, kitchen sink, laundry tub, in a wet basement, or near a swimming pool, etc.
- 6 Carts and Stands – The unit should be used only with a cart or stand that is recommended by the manufacturer.
- 6A A unit and cart combination should be moved with care. Quick stops, excessive force, and uneven surfaces may cause the unit and cart combination to overturn.
- 7 Wall or Ceiling Mounting – The unit should be mounted to a wall or ceiling only as recommended by the manufacturer.



- 8 Ventilation – The unit should be situated so that its location or position does not interfere with its proper ventilation. For example, the unit should not be situated on a bed, sofa, rug, or similar surface, that may block the ventilation openings; or placed in a built-in installation, such as a bookcase or cabinet that may impede the flow of air through the ventilation openings.
- 9 Heat – The unit should be situated away from heat sources such as radiators, stoves, or other appliances that produce heat.
- 10 Power Sources – The unit should be connected to a power supply only of the type described in the operating instructions or as marked on the unit.
- 11 Power-Cord Protection – Power-supply cords should be routed so that they are not likely to be walked on or pinched by items placed upon or against them, paying particular attention to cords at plugs, convenience receptacles, and the point where they exit from the unit.
- 12 Cleaning – The unit should be cleaned only as recommended by the manufacturer.
- 13 Nonuse Periods – The power cord of the unit should be unplugged from the outlet when left unused for a long period of time.
- 14 Object and Liquid Entry – Care should be taken so that objects do not fall into and liquids are not spilled into the inside of the unit.
- 15 Damage Requiring Service – The unit should be serviced by qualified service personnel when:
  - A. The power-supply cord or the plug has been damaged; or
  - B. Objects have fallen, or liquid has been spilled into the unit; or
  - C. The unit has been exposed to rain; or
  - D. The unit does not appear to operate normally or exhibits a marked change in performance; or
  - E. The unit has been dropped, or the cabinet damaged.
- 16 Servicing – The user should not attempt to service the unit beyond those means described in the operating instructions. All other servicing should be referred to qualified service personnel.
- 17 Power Lines – An outdoor antenna should be located away from power lines.
- 18 Grounding or Polarization – Precautions should be taken so that the grounding or polarization is not defeated.

**19 For US customers only:**

Outdoor Antenna Grounding – If an outside antenna is connected to this unit, be sure the antenna system is grounded so as to provide some protection against voltage surges and built-up static charges. Article 810 of the National Electrical Code, ANSI/NFPA 70, provides information with regard to proper grounding of the mast and supporting structure, grounding of the lead-in wire to an antenna discharge unit, size of grounding conductors, location of antenna discharge unit, connection to grounding electrodes, and requirements for the grounding electrode.

**Note to CATV system installer:**

This reminder is provided to call the CATV system installer's attention to Article 820-40 of the NEC that provides guidelines for proper grounding and, in particular, specifies that the cable ground shall be connected to the grounding system of the building, as close to the point of cable entry as practical.

EXAMPLE OF ANTENNA GROUNDING

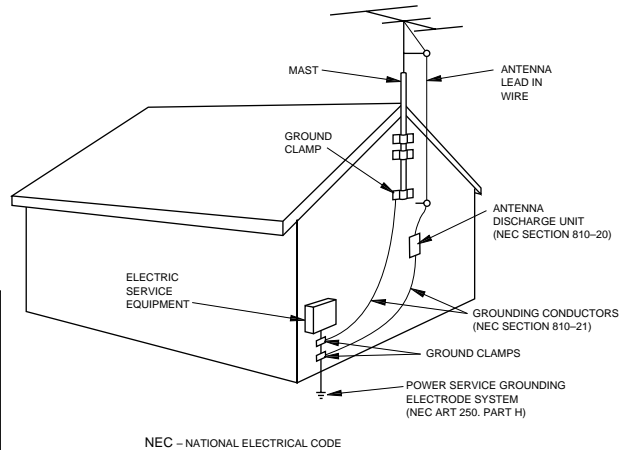
**FCC INFORMATION (for US customers only)****1. IMPORTANT NOTICE : DO NOT MODIFY THIS UNIT!**

This product, when installed as indicated in the instructions contained in this manual, meets FCC requirements. Modifications not expressly approved by Yamaha may void your authority, granted by the FCC, to use the product.

**2. IMPORTANT :** When connecting this product to accessories and/or another product use only high quality shielded cables. Cable/s supplied with this product **MUST** be used. Follow all installation instructions. Failure to follow instructions could void your FCC authorization to use this product in the USA.**3. NOTE :** This product has been tested and found to comply with the requirements listed in FCC Regulations, Part 15 for Class "B" digital devices. Compliance with these requirements provides a reasonable level of assurance that your use of this product in a residential environment will not result in harmful interference with other electronic devices.

This equipment generates/uses radio frequencies and, if not installed and used according to the instructions found in the users manual, may cause interference harmful to the operation of other electronic devices.

Compliance with FCC regulations does not guarantee that interference will not occur in all installations. If this product is found to be the source of interference, which can be determined by turning the unit "OFF" and "ON", please try to eliminate the problem by using one of the following measures:

Relocate either this product or the device that is being affected by the interference.

Utilize power outlets that are on different branch (circuit breaker or fuse) circuits or install AC line filter/s.

In the case of radio or TV interference, relocate/reorient the antenna. If the antenna lead-in is 300 ohm ribbon lead, change the lead-in to coaxial type cable.

If these corrective measures do not produce satisfactory results, please contact the local retailer authorized to distribute this type of product. If you can not locate the appropriate retailer, please contact Yamaha Electronics Corp., U.S.A. 6660 Orangethorpe Ave, Buena Park, CA 90620.

The above statements apply **ONLY** to those products distributed by Yamaha Corporation of America or its subsidiaries.

**We Want You Listening For A Lifetime**

YAMAHA and the Electronic Industries Association's Consumer Electronics Group want you to get the most out of your equipment by playing it at a safe level. One that lets the sound come through loud and clear without annoying blaring or distortion – and, most importantly, without affecting your sensitive hearing.

Since hearing damage from loud sounds is often undetectable until it is too late, YAMAHA and the Electronic Industries Association's Consumer Electronics Group recommend you to avoid prolonged exposure from excessive volume levels.



# CAUTION: READ THIS BEFORE OPERATING YOUR UNIT.

- 1 To assure the finest performance, please read this manual carefully. Keep it in a safe place for future reference.
- 2 Install this unit in a well ventilated, cool, dry, clean place with at least 30 cm on the top, 20 cm on the right and left, and 10 cm at the back of this unit for ventilation space — away from direct sunlight, heat sources, vibration, dust, moisture, and/or cold.
- 3 Locate this unit away from other electrical appliances, motors, or transformers to avoid humming sounds. To prevent fire or electrical shock, do not place this unit where it may get exposed to rain, water, and/or any type of liquid.
- 4 Do not expose this unit to sudden temperature changes from cold to hot, and do not locate this unit in a environment with high humidity (i.e. a room with a humidifier) to prevent condensation inside this unit, which may cause an electrical shock, fire, damage to this unit, and/or personal injury.
- 5 On the top of this unit, do not place:
  - Other components, as they may cause damage and/or discoloration on the surface of this unit.
  - Burning objects (i.e. candles), as they may cause fire, damage to this unit, and/or personal injury.
  - Containers with liquid in them, as they may cause electrical shock to the user and/or damage to this unit.
- 6 Do not cover this unit with a newspaper, tablecloth, curtain, etc. in order not to obstruct heat radiation. If the temperature inside this unit rises, it may cause fire, damage to this unit, and/or personal injury.
- 7 Do not plug in this unit to a wall outlet until all connections are complete.
- 8 Do not operate this unit upside-down. It may overheat, possibly causing damage.
- 9 Do not use force on switches, knobs and/or cords.
- 10 When disconnecting the power cord from the wall outlet, grasp the plug; do not pull the cord.
- 11 Do not clean this unit with chemical solvents; this might damage the finish. Use a clean, dry cloth.
- 12 Only voltage specified on this unit must be used. Using this unit with a higher voltage than specified is dangerous and may cause fire, damage to this unit, and/or personal injury. YAMAHA will not be held responsible for any damage resulting from use of this unit with a voltage other than specified.
- 13 To prevent damage by lightning, disconnect the power cord from the wall outlet during an electrical storm.
- 14 Take care of this unit so that no foreign objects and/or liquid drops inside this unit.
- 15 Do not attempt to modify or fix this unit. Contact qualified YAMAHA service personnel when any service is needed. The cabinet should never be opened for any reasons.
- 16 When not planning to use this unit for long periods of time (i.e. vacation), disconnect the AC power plug from the wall outlet.
- 17 Be sure to read the “TROUBLESHOOTING” section on common operating errors before concluding that this unit is faulty.
- 18 Before moving this unit, press STANDBY/ON to set this unit in the standby mode, and disconnect the AC power plug from the wall outlet.
- 19 **VOLTAGE SELECTOR (China and General models only)**  
The VOLTAGE SELECTOR on the rear panel of this unit must be set for your local main voltage BEFORE plugging into the AC main supply. Voltages are 110/120/220/240 V AC, 50/60 Hz.

This unit is not disconnected from the AC power source as long as it is connected to the wall outlet, even if this unit itself is turned off. This state is called the standby mode. In this state, this unit is designed to consume a very small quantity of power.

## FREQUENCY STEP switch (China and General models only)

Because the interstation frequency spacing differs in different areas, set the FREQUENCY STEP switch (locating at the rear) according to the frequency spacing in your area.

North, Central and South America: 100 kHz/10 kHz  
Other area: 50 kHz/9 kHz

Before setting this switch, disconnect the AC power plug of this unit from the AC outlet.

## IMPORTANT

Please record the serial number of this unit in the space below.

MODEL:

Serial No.:

The serial number is located on the rear of the unit.

Retain this Owner's Manual in a safe place for future reference.

## FOR CANADIAN CUSTOMERS

To prevent electric shock, match wide blade of plug to wide slot and fully insert.

This Class B digital apparatus complies with Canadian ICES-003.

# CONTENTS

## INTRODUCTION

<b>FEATURES</b> .....	2
<b>GETTING STARTED</b> .....	3
Checking the Package Contents .....	3
Installing Batteries in the Remote Control .....	3
<b>CONTROLS AND FUNCTIONS</b> .....	4
Front Panel .....	4
Remote Control .....	6
Description of the Numeric Buttons .....	7
Using the Remote Control .....	8
Front Panel Display .....	9
Rear Panel .....	10

## PREPARATION

<b>SPEAKER SETUP</b> .....	11
Speakers to Be Used .....	11
Speaker Placement .....	11
<b>CONNECTIONS</b> .....	12
Before Connecting Components .....	12
Connecting Audio Components .....	12
Connecting an External Decoder .....	13
Connecting Video Components .....	14
Connecting the Speakers .....	16
IMPEDANCE SELECTOR Switch .....	18
Connecting the Power Supply Cords .....	18
<b>ON-SCREEN DISPLAY (OSD)</b> .....	19
OSD Modes .....	19
Selecting the OSD Mode .....	19
<b>SPEAKER MODE SETTINGS</b> .....	20
Summary of SPEAKER SET Items	
1A through 1E .....	20
<b>ADJUSTING THE SPEAKER OUTPUT</b>	
<b>LEVELS</b> .....	21
Before You Begin .....	21
Using the Test Tone (TEST DOLBY SUR.) .....	21

## BASIC OPERATION

<b>BASIC PLAYBACK</b> .....	23
Input Modes and Indications .....	25
Selecting a Sound Field Program .....	27
Normal Stereo Reproduction .....	28
<b>TUNING</b> .....	29
Connecting the Antennas .....	29
Automatic (or Manual) Tuning .....	30
Presetting Stations .....	31
Tuning in to a Preset Station .....	32
Exchanging Preset Stations .....	33
<b>BASIC RECORDING</b> .....	34

## ADVANCED OPERATION

<b>SET MENU</b> .....	35
Adjusting the Items on the SET MENU .....	35
1 SPEAKER SET (speaker mode settings) .....	36
2 L/R BALANCE (balance of the left and right main speakers) .....	38
3 HP TONE CTRL (headphone tone control) .....	39
4 I/O ASSIGNMENT .....	39
5 INPUT MODE (initial input mode) .....	39
6 DOLBY D. SET (Dolby Digital set) .....	40
7 DTS SET (DTS LFE level) .....	40
8 SP DELAY TIME .....	41
9 DISPLAY SET .....	41
10 MEMORY GUARD .....	41
<b>ADJUSTING THE LEVEL OF THE EFFECT</b>	
<b>SPEAKERS</b> .....	42
<b>SLEEP TIMER</b> .....	43
Setting the Sleep Timer .....	43
Canceling the Sleep Timer .....	43
<b>REMOTE CONTROL FEATURES</b> .....	44
Selector Dial .....	44
Commonly Used Buttons in Any Position of the Selector Dial .....	45
Controlling the Components Connected to This Unit .....	45
Button Names and Functions in Each Position .....	46
Setting the Manufacturer Code .....	49
Returning to the Factory Setting .....	50

## ADDITIONAL INFORMATION

<b>SOUND FIELD PROGRAM</b> .....	51
Hi-Fi DSP Programs .....	51
CINEMA DSP Programs .....	51
<b>SOUND FIELD PROGRAM PARAMETER</b>	
<b>EDITING</b> .....	54
What is a sound field? .....	54
Sound Field Program Parameters .....	54
Changing Parameter Settings .....	55
Resetting a Parameter to the Factory-set Value .....	55
Sound Field Parameter Descriptions .....	56

## APPENDIX

<b>TROUBLESHOOTING</b> .....	59
<b>SPECIFICATIONS</b> .....	64
<b>GLOSSARY</b> .....	65
<b>INDEX</b> .....	67

# FEATURES

## Built-in 5-Channel Power Amplifier

- ◆ Minimum RMS Output Power (0.06% THD, 20 Hz – 20 kHz)  
[U.S.A. and Canada models]  
Main: 100 W + 100 W (8 Ω)  
Center: 100 W (8 Ω)  
Rear: 100 W + 100 W (8 Ω)  
[Australia, Singapore, China and General models]  
Main: 90 W + 90 W (8 Ω)  
Center: 90 W (8 Ω)  
Rear: 90 W + 90 W (8 Ω)
- ◆ Maximum Power (EIAJ) (10% THD, 1 kHz)  
[China and General models]  
Main: 115 W + 115 W (8 Ω)  
Center: 115 W (8 Ω)  
Rear: 115 W + 115 W (8 Ω)

## Multi-Mode Digital Sound Field Processing

- ◆ DTS Decoder
- ◆ Dolby Pro Logic Decoder
- ◆ Dolby Digital Decoder
- ◆ Hi-Fi DSP
- ◆ CINEMA DSP: Combination of YAMAHA DSP Technology and Dolby Pro Logic, Dolby Digital or DTS
- ◆ Virtual CINEMA DSP
- ◆ SILENT CINEMA

## Sophisticated AM/FM Tuner

- ◆ 40-Station Random Access Preset Tuning
- ◆ Automatic Preset Tuning
- ◆ Preset Station Shifting Capability (Preset Editing)

## Other Features

- ◆ 96-kHz/24-bit D/A Converter
- ◆ “SET MENU” which Provides You with 10 Items for Optimizing This Unit for Your Audio/Video System
- ◆ Test Tone Generator for Easier Speaker Balance Adjustment
- ◆ 6-Channel External Decoder Input for Other Future Formats
- ◆ BASS EXTENSION Button for Reinforcing Bass Response
- ◆ On Screen Display Function Helpful in Controlling This Unit
- ◆ S Video Signal Input/Output Capability
- ◆ Component Video Input/Output Capability
- ◆ Optical and Coaxial Digital Audio Signal Jacks
- ◆ Sleep Timer
- ◆ Remote Control with Preset Manufacturer Codes

-  indicates a tip for your operation.
- Some operations can be performed by using either the buttons on the main unit or on the remote control. In cases when the button names differ between the main unit and the remote control, the button name on the remote control is given in parentheses in this manual.



Manufactured under license from Dolby Laboratories.

“Dolby”, “AC-3”, “Pro Logic” and the double-D symbol are trademarks of Dolby Laboratories.  
Confidential Unpublished Works. ©1992-1997 Dolby Laboratories, Inc. All rights reserved.



Manufactured under license from Digital Theater Systems, Inc. US Pat. No. 5,451,942 and other world-wide patents issued and pending. “DTS” and “DTS Digital Surround” are trademarks of Digital Theater Systems, Inc. Copyright 1996 Digital Theater Systems, Inc. All Rights Reserved.

# GETTING STARTED

## Checking the Package Contents

Check your package to make sure it has the following items.

### Remote control

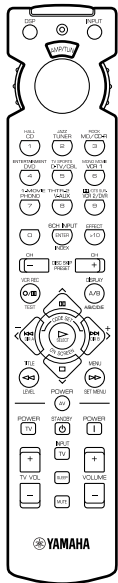

### Batteries (4) (AAA, R03, UM-4)

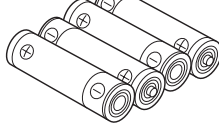

### Indoor FM antenna (U.S.A., Canada, China and General models)

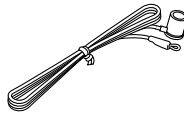

### (Australia and Singapore models)

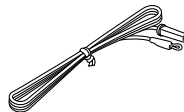

### AM loop antenna

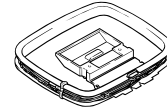

### Quick Reference Card

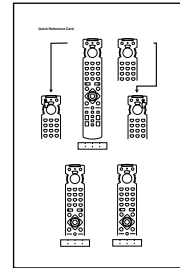

### Connection guide

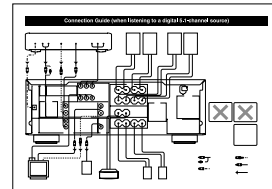

## Installing Batteries in the Remote Control

Insert the batteries in the correct direction by aligning the + and – marks on the batteries with the polarity markings (+ and –) inside the battery compartment.

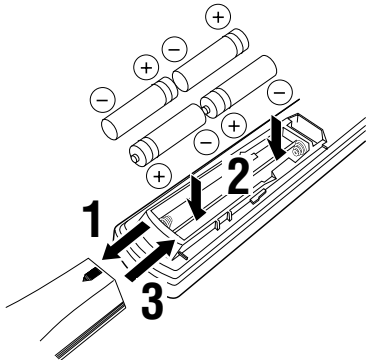

### ■ Notes on batteries

- Change the batteries periodically.
- Do not use old batteries together with new ones.
- Do not use different types of batteries (such as alkaline and manganese batteries) together. Read the packaging carefully as these different types of batteries may have the same shape and color.

### ■ Changing batteries

As the batteries lose power, the operating range of the remote control decreases and the indicator does not flash or its light becomes dim. When you notice any of these conditions, change all of the batteries.

If the remote control is without batteries for more than 2 minutes, or if exhausted batteries remain in the remote control, the contents of the memory may be cleared. When the memory is cleared, insert new batteries, set up the manufacturer code that may have been cleared.

### Note

- If the batteries have leaked, dispose of them immediately. Avoid touching the leaked material or letting it come into contact with clothing, etc. Clean the battery compartment thoroughly before installing new batteries.

# CONTROLS AND FUNCTIONS

## Front Panel

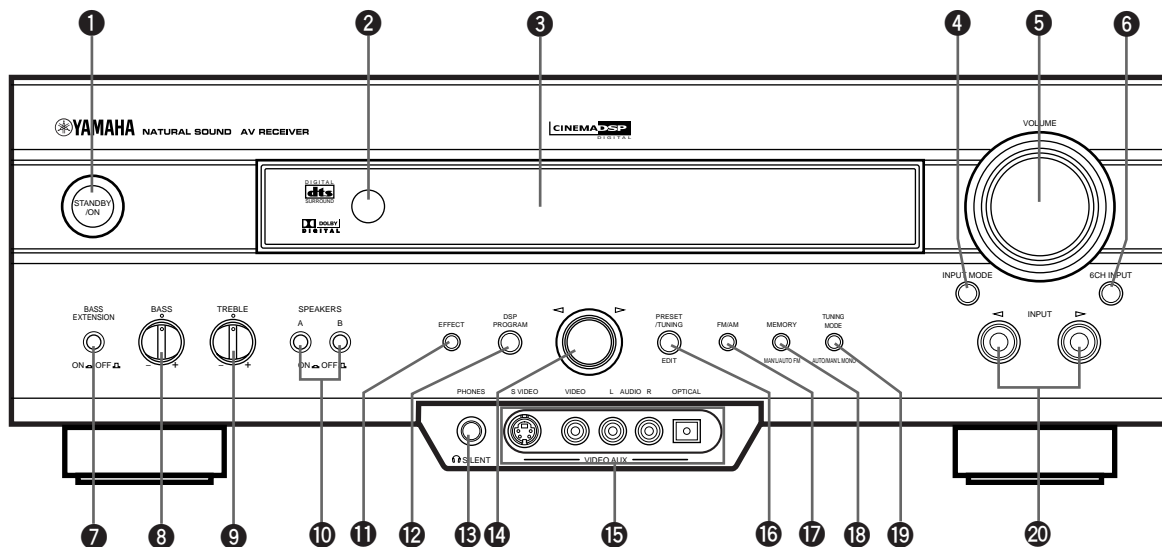

### 1 STANDBY/ON

Turns on or sets this unit in the standby mode. When you turn on this unit, you will hear a click and there will be a 4 to 5-second delay before this unit can reproduce sound.

#### Standby mode

In this mode, this unit consumes a small amount of power to receive infrared-signals from the remote control.

### 2 Remote control sensor

Receives signals from the remote control.

### 3 Front panel display

Shows information about the operational status of this unit.

### 4 INPUT MODE

Selects the mode of input for sources that send two or more types of signals to this unit (see page 25 for details). You cannot control the input mode when you select 6CH INPUT as the input source.

### 5 VOLUME

Controls the output level of all audio channels. This does not affect the REC OUT level.

### 6 6CH INPUT

Selects the source connected to the 6CH INPUT jacks. The source selected by pressing 6CH INPUT takes priority over the source selected with INPUT ◀/▶ (or the input selector buttons on the remote control).

### 7 BASS EXTENSION ON/OFF

When pushed in (ON), this feature boosts the bass frequency of the left and right main speakers by +6 dB (60 Hz) while maintaining overall tonal balance. This boost is useful if you do not use a subwoofer. However, this boost may not be noticeable if "1B MAIN SP" on the SET MENU is set to SMALL and "1D LFE/BASS OUT" is set to SWFR.



**8 BASS**

Adjusts the low-frequency response for the left and right main speakers.

Turn the control to the right to increase or to the left to decrease the low-frequency response.

**9 TREBLE**

Adjusts the high-frequency response for the left and right main speakers.

Turn the control to the right to increase or to the left to decrease the high-frequency response.

**Note**

- If you increase or decrease the high-frequency or the low-frequency sound to an extreme level, the tonal quality from the center and rear speakers may not match that of the left and right main speakers.

**10 SPEAKERS A/B**

When pushed in (ON), these buttons turn on the set of main speakers connected to the A and/or B terminals on the rear panel.

**11 EFFECT**

Switches the effect speakers (center and rear) on and off. If you turn off the output of these speakers by using EFFECT, all Dolby Digital and DTS audio signals except for the LFE channel are directed to the main left and right channels.

When Dolby Digital or DTS signals are mixed, the left and right main channel signal levels may not match.

**12 DSP PROGRAM**

Switches the function of the multi jog knob for selecting DSP program.

**13 PHONES jack**

Outputs audio signals for private listening with headphones. When you connect headphones, no signals are output to the speakers.

**14 Multi jog knob**

Selects the tuning frequency in the tuning mode.

Selects the preset station after pressing PRESET/TUNING (EDIT) to display “>`” in the tuning mode.

Selects the DSP program after pressing DSP PROGRAM.

**15 VIDEO AUX jacks**

Inputs audio and video signals from a portable external source such as a game console. To reproduce source signals from these jacks, select V-AUX as the input source.

**16 PRESET/TUNING (EDIT)**

Switches the function of the multi jog knob between selecting a preset station number and tuning.

This button is also used to exchange the assignment of two preset stations with each other.

**17 FM/AM**

Switches the reception band between FM and AM.

**18 MEMORY (MAN'L/AUTO FM)**

Stores a station in the memory. Hold down this button for more than 3 seconds to start automatic preset tuning (for FM stations only).

**19 TUNING MODE (AUTO/MAN'L MONO)**

Switches the tuning mode between automatic and manual. To select the automatic tuning mode, press this button so that the “AUTO” indicator lights up on the front panel display again. To select the manual tuning mode, press this button so that the “AUTO” indicator does not light up.

**20 INPUT ◀/▶**

Selects the input source (CD, TUNER, MD/CD-R, DVD, D-TV/CBL, VCR 1, PHONO, V-AUX, VCR 2/DVR) you want to listen to or watch.

## Remote Control

This section describes the basic operation of this unit with the remote control. First, set the selector dial to the AMP/TUN position. See “REMOTE CONTROL FEATURES” for full details.

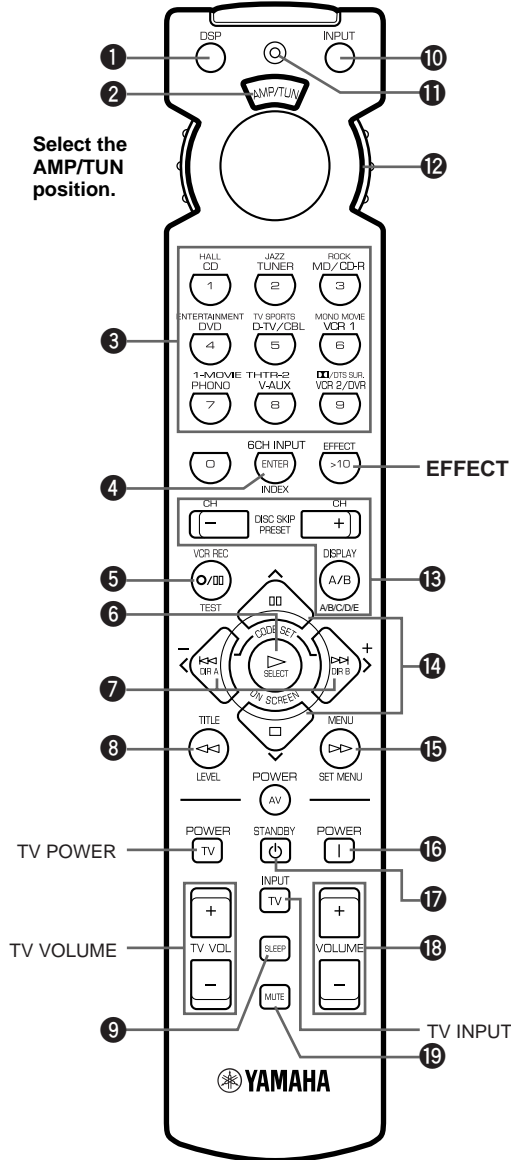

Select the AMP/TUN position.

- 1 DSP**  
Switches the function of the numeric buttons to the DSP program selector.
- 2 Indicator window**  
Shows the name of components which can be controlled.

### 3 Numeric buttons (Input selector buttons)

These buttons select the input source.  
See “Description of the Numeric Buttons” for the numeric buttons.

### 4 6CH INPUT

Selects the source connected to the 6CH INPUT jacks.

### 5 TEST

Outputs the test tone.

### 6 ON SCREEN

Selects the on-screen display (OSD) mode for your video monitor.

### 7 </> (-/+)

Adjust DSP program parameters and SET MENU items.  
-/+ is displayed on the on-screen display.

### 8 LEVEL

Selects the effect speaker channel (center, rear and subwoofer) so you can adjust their output level independently.

### 9 SLEEP

Sets the sleep timer.

### 10 INPUT

Switches the function of the numeric buttons to the input selector.

### 11 Indicator

Flashes while the remote control is sending signals.

### 12 Selector dial

Turn this dial to select the position for the component to be controlled. (The proper code must be set up for your component. See “Setting the Manufacture Codes”.) When a position is selected, the remote control is set to that component operation mode.

### 13 A/B/C/D/E, PRESET -/+

These buttons are used to select a preset station.

A/B/C/D/E: To select one of 5 preset station groups (A to E)

PRESET -/+ : To select a preset station number (1 to 8)

### 14 ^/v

Select DSP program parameters and SET MENU items.

### 15 SET MENU

Enters the SET MENU.

### 16 POWER

Turns on the power of this unit.

### 17 STANDBY

Sets this unit in the standby mode.

**18 VOLUME +/-**

Increases or decreases the volume level.

**19 MUTE**

Mutes the sound. Press again to restore the audio output to the previous volume level.

**EFFECT**

Switches the effect speakers (center and rear) on and off in the following cases:

- When the selector dial is set to the DSP/TUN position.
- While the indicator is lit for about 3 seconds after pressing DSP.

**Description of the Numeric Buttons**

The numeric buttons function in various ways depending on the position of the selector dial or the combination of other instructions.

**When selecting an input source**

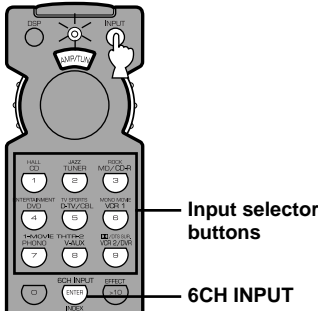

**1** Press INPUT regardless of the position of the selector dial. The indicator lights up for about 3 seconds.

**2** You can select an input source with the numeric buttons and 6CH INPUT while the indicator is lit.

**When selecting a DSP program and turning on or off the effect speakers (center and rear)**

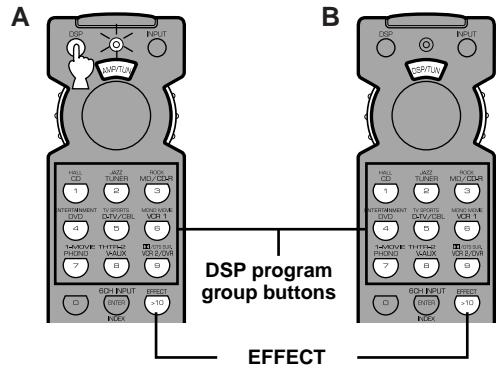

**A**

**1** Press DSP regardless of the position of the selector dial. The indicator lights up for about 3 seconds.

**2** You can select a DSP program with the numeric buttons and turn on or off the effect speakers (center and rear) by pressing EFFECT while the indicator is lit.

**B**

**1** Set the selector dial to the DSP/TUN position.

**2** You can select a DSP program directly with the numeric buttons and turn on or off the effect speakers (center and rear) by pressing EFFECT.

■ When selecting a preset station number

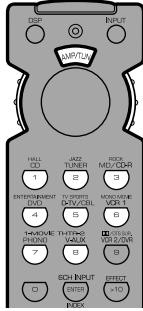

- 1** Set code number “0023” in the AMP/TUN (or DSP/TUN) position.  
See “Setting the Manufacturer Code” for setting the code.
- 2** Set the selector dial to the AMP/TUN (or DSP/TUN) position.
- 3** You can select a preset station number directly with the numeric buttons (1 to 8).  
See “Tuning in to a Preset Station”.

*Using the Remote Control*

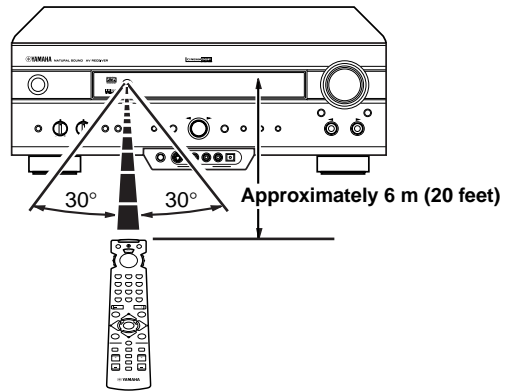

The remote control transmits a directional infrared beam. Be sure to aim the remote control directly at the remote control sensor on the main unit during operation.

■ Handling the remote control

- Do not spill water or other liquids on the remote control.
- Do not drop the remote control.
- Do not leave or store the remote control in the following types of conditions:
  - high humidity or temperature such as near a heater, stove or bath;
  - dusty places; or
  - in places subject to extremely low temperatures.

## Front Panel Display

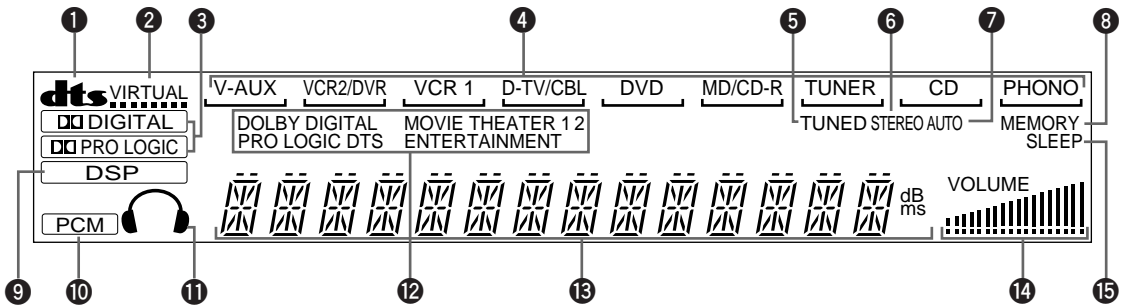

### 1 **dts** indicator

Lights up when the built-in DTS decoder is on.

### 2 **VIRTUAL** indicator

Lights up when using Virtual CINEMA DSP.

### 3 **DIGITAL** and **PRO LOGIC** indicators

Light up according to the type of Dolby signals this unit is reproducing. “**DIGITAL**” lights up when the built-in Dolby Digital decoder is on. “**PRO LOGIC**” lights up when the built-in Dolby Pro Logic decoder is on.

### 4 **Input source** indicator

Shows the current input source with a cursor.

### 5 **TUNED** indicator

Lights up when this unit tunes in to a station.

### 6 **STEREO** indicator

Lights up when the unit is receiving a strong signal for an FM stereo broadcast while the “**AUTO**” indicator is lit.

### 7 **AUTO** indicator

Shows that this unit is in the automatic tuning mode.

### 8 **MEMORY** indicator

Flashes to show a station can be stored.

### 9 **DSP** indicator

Lights up when you select a DSP program.

### 10 **PCM** indicator

Lights up when this unit is reproducing PCM (pulse code modulation) digital audio signals.

### 11 **Headphones** indicator

Lights up when headphones are connected.

### 12 **DSP program** indicators

The name of the selected DSP program lights up when the ENTERTAINMENT, MOVIE THEATER 1, MOVIE THEATER 2 or **DTS SURROUND** DSP program is selected.

### 13 **Multi-information** display

Shows the current DSP program name and other information when adjusting or changing settings.

### 14 **VOLUME** level indicator

Indicates the volume level.

### 15 **SLEEP** indicator

Lights up while the sleep timer is on.

# Rear Panel

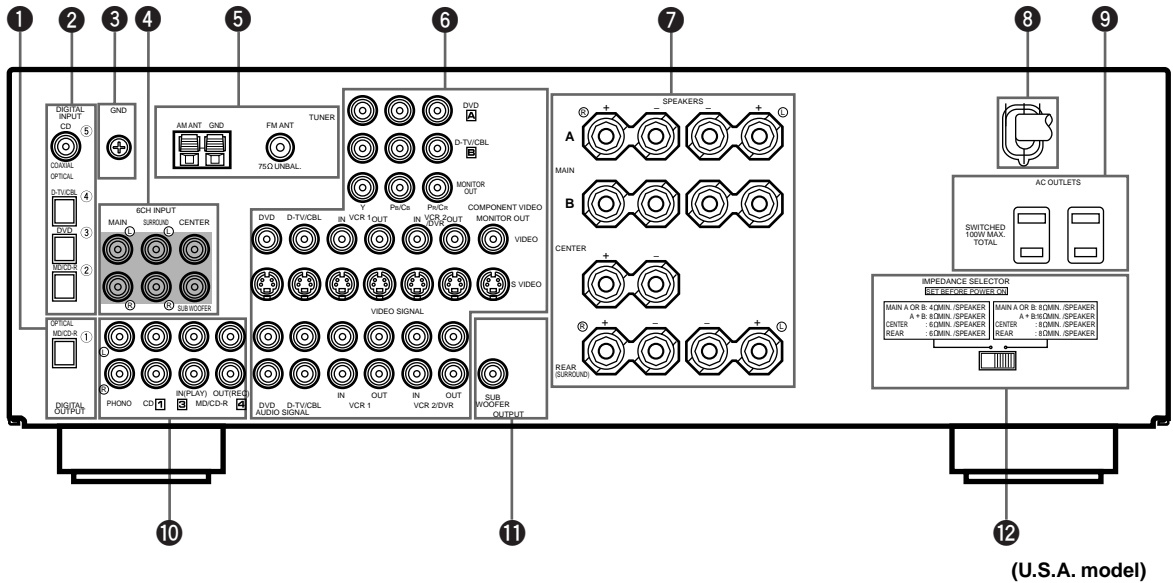

(U.S.A. model)

**1 DIGITAL OUTPUT jacks**

**2 DIGITAL INPUT jacks**

**3 GND terminal**

See page 12 for connection information.

**4 6CH INPUT jacks**

See page 13 for connection information.

**5 Antenna input terminals**

See page 29 for connection information.

**6 Video component jacks**

See pages 14 and 15 for connection information.

**7 Speaker terminals**

See pages 16 and 17 for connection information.

**8 AC power cord**

Connect to a power outlet.

**9 AC OUTLET(S)**

Use these outlets to supply power to your other audio/video components (see page 18).

**10 Audio component jacks**

See pages 12 and 13 for connection information.

**11 SUBWOOFER jack**

See page 17 for connection information.

**12 IMPEDANCE SELECTOR switch**

Use this switch to match the amplifier output to your speaker impedance. Set this unit in the standby mode before you change the setting of this switch (see page 18).

**China and General models only**

**FREQUENCY STEP switch**

See page 29.

**VOLTAGE SELECTOR**

See page 18.

# SPEAKER SETUP

## Speakers to Be Used

This unit has been designed to provide the best sound-field quality with a 5-speaker system, using left and right main speakers, left and right rear speakers, and a center speaker. If you use different brands of speakers (with different tonal qualities) in your system, the tone of a moving human voice and other types of sound may not shift smoothly. We recommend that you use speakers from the same manufacturer to ensure even tonal quality.

The main speakers are used for the main source sound plus the effect sounds. They will probably be the speakers from your present stereo system. The rear speakers are used for the effect and surround sounds, and the center speaker is for the center sounds (dialog, vocals, etc.). If for some reason it is not practical to use a center speaker, you can do without it. Best results, however, are obtained with the full system.

The main speakers should be high-performance models and have enough power-handling capacity to accept the maximum output of your audio system. The other speakers do not have to be equal to the main speakers. For precise sound localization, however, it is ideal to use high-performance models that can reproduce sounds over the full range for the center speaker and the rear speakers.

### ■ Use of a subwoofer expands your sound field

It is also possible to further expand your system with the addition of a subwoofer. The use of a subwoofer is effective not only for reinforcing bass frequencies from any or all channels, but also for reproducing the LFE (low-frequency effect) channel with high fidelity when the Dolby Digital signal or the DTS signal is played back. The YAMAHA Active Servo Processing Subwoofer System is ideal for natural and lively bass reproduction.

## Speaker Placement

Refer to the following diagram when you place the speakers.

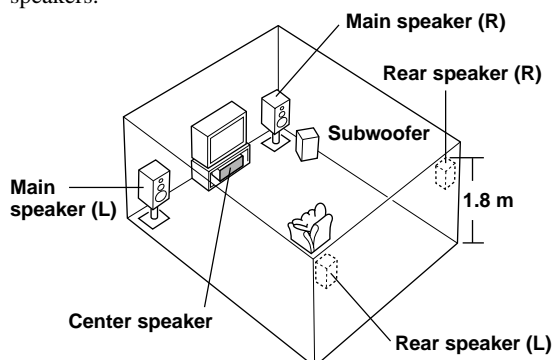

### ■ Main speakers

Place the left and right main speakers an equal distance from the ideal listening position. The distance of each speaker from each side of the video monitor should be the same.

### ■ Rear speakers

Place these speakers behind your listening position, facing slightly inwards, nearly 1.8 m (approx. 6 feet) above the floor.

### ■ Center speaker

Align the front face of the center speaker with the front face of your video monitor. Place the speaker as close to the monitor as possible, such as directly over or under the monitor and centrally between the main speakers.

#### Note

- If the center speaker is not used, the center channel sound will be heard from the left and right main speakers. In this case, "1A CENTER SP" on the SET MENU is set to NONE.

### ■ Subwoofer

The position of the subwoofer is not so critical, because low bass sounds are not highly directional. But it is better to place the subwoofer near the main speakers. Turn it slightly toward the center of the room to reduce the wall reflections.

#### CAUTION

Please use magnetically shielded speakers. Sometimes a video monitor may be adversely affected even when magnetically shielded speakers are used. Separate the speakers from the monitor if this happens.

# CONNECTIONS

## Before Connecting Components

### CAUTION

Never connect this unit and other components to mains power until all connections between components have been completed.

- Be sure all connections are made correctly, that is to say L (left) to L, R (right) to R, “+” to “+” and “-” to “-”. Some components require different connection methods and have different jack names. Refer to the operation instructions for each component to be connected to this unit.
- When you connect other YAMAHA audio components (such as a tape deck, MD recorder and CD player or changer), connect them to the jack with the same number labels as 1, 3, 4 etc.
- After you have completed all connections, check them again to make sure they are correct.

## Connecting Audio Components

### ■ Connecting to digital jacks

This unit has digital jacks for direct transmission of digital signals through either coaxial or fiber optic cables. You can use the digital jacks to input PCM, Dolby Digital and DTS bitstreams. When you connect components to both the COAXIAL and OPTICAL jacks, priority is given to the input signals from the COAXIAL jack. All digital input jacks are acceptable for 96-kHz sampling digital signals.



- You can designate the input for each digital jack according to your component by using “4 I/O ASSIGNMENT” on the SET MENU.

### About the dust protection cap

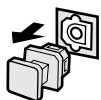

Pull out the cap from the optical jack before you connect the fiber optic cable. Do not discard the cap. When you are not using the optical jack, be sure to put the cap back in place. This cap protects the jack from dust.

### Note

- The OPTICAL jacks on this unit conform to the EIA standard. If you use a fiber optic cable that does not conform to this standard, this unit may not function properly.

### ■ Connecting a turntable

PHONO jacks are for connecting a turntable with an MM or high-output MC cartridge. If you have a turntable with a low-output MC cartridge, use an inline boosting transformer or MC-head amplifier when connecting to these jacks.



- The GND terminal does not electrically ground the turntable. It simply reduces noise in the signal. In some cases, you may hear less noise if you do not connect to the GND terminal.

### ■ Connecting a CD player



- The COAXIAL jack is available for a CD player which has a coaxial digital output jack.
- When you connect a CD player to both the analog and digital jacks, priority is given to the input signals from the digital jack.

### ■ Connecting an MD recorder, CD recorder or tape deck



- When you connect your recording component to both the analog and digital input and output jacks, the priority is given to the digital signal.

### Notes

- When you connect a recording component to this unit, keep its power on while using this unit. If the power is off, this unit may distort the sound from other components.
- Since digital output and analog output (REC OUT) are independent of each other, the analog signal is output only to the analog jack, while the digital signal is output only to the digital jack.



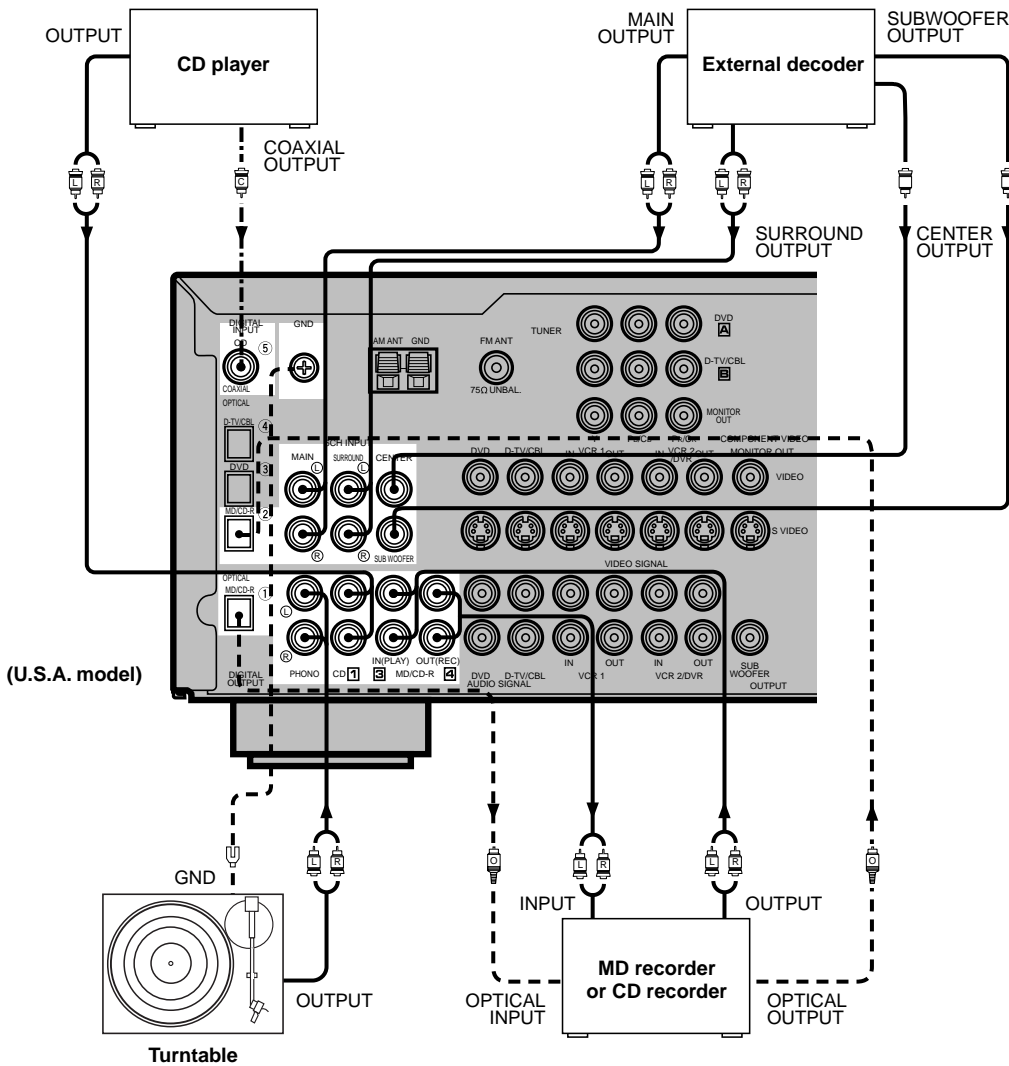

(U.S.A. model)

- ▶— indicates signal direction
- (L)— indicates left analog cables
- (R)— indicates right analog cables
- - - (O) - indicates optical cables
- - - (C) - indicates coaxial cables

### Connecting an External Decoder

This unit is equipped with 6 additional input jacks (left and right MAIN, CENTER, left and right SURROUND and SUBWOOFER) for discrete multi-channel input from an external decoder, sound processor or pre-amplifier.

Connect the output jacks on your external decoder to the 6CH INPUT jacks. Be sure to match the left and right outputs to the left and right input jacks for the main and surround channels.

#### Notes

- When you select 6CH INPUT as the input source, this unit automatically turns off the digital sound field processor, and you cannot listen to DSP programs.
- When you select 6CH INPUT as the input source, changing items 1A to 1E on the SET MENU is not affected.

PREPARATION

English

## Connecting Video Components

### About the video jacks

There are three types of video jacks. Video signals input through the VIDEO jacks are the conventional composite video signals. Video signals input through the S VIDEO jacks are separated into luminance (Y) and color (C) video signals. The S-video signals achieve high-quality color reproduction. Video signals input through the COMPONENT VIDEO jacks are separated into luminance (Y) and color difference (P<sub>B</sub>/C<sub>B</sub>, P<sub>R</sub>/C<sub>R</sub>) video signals. The jacks are also separated into three for each signal. The description of the component video jacks may be different depending on the component (e.g. Y, C<sub>B</sub>, C<sub>R</sub>/Y, P<sub>B</sub>, P<sub>R</sub>/Y, B-Y, R-Y etc.). Component video signals provide the best quality in picture reproduction.

If your video component has an S-video output or component video output, you can connect it to this unit. Connect the S-video signal output jack on your video component to the S VIDEO jack or connect the component signal output jacks on your video component to the COMPONENT VIDEO jacks.



VIDEO jack (composite)



S VIDEO jack



COMPONENT VIDEO jacks



- Each type of video jack works independently. Signals input through the composite video, S-video and component jacks are output through the corresponding composite video, S-video, and component jacks, respectively.
- If you make S-video connections to this unit, it is not necessary to make composite video connections. If both types of connections are made, this unit gives priority to the S-video signal.
- You can designate the input for the COMPONENT VIDEO A and B jacks according to your component by using "4 I/O ASSIGNMENT" on the SET MENU.

#### Notes

- Use a commercially available S-video cable when connecting to the S VIDEO jack, and commercially available video cables when connecting to the COMPONENT VIDEO jacks.
- When you are using the COMPONENT VIDEO jacks, check the details in the owner's manual that came with the component being connected.

### VIDEO AUX jacks (on the front panel)

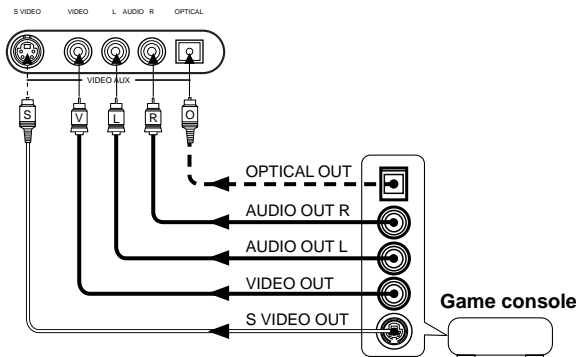

These jacks are used to connect any video input source such as a game console to this unit.

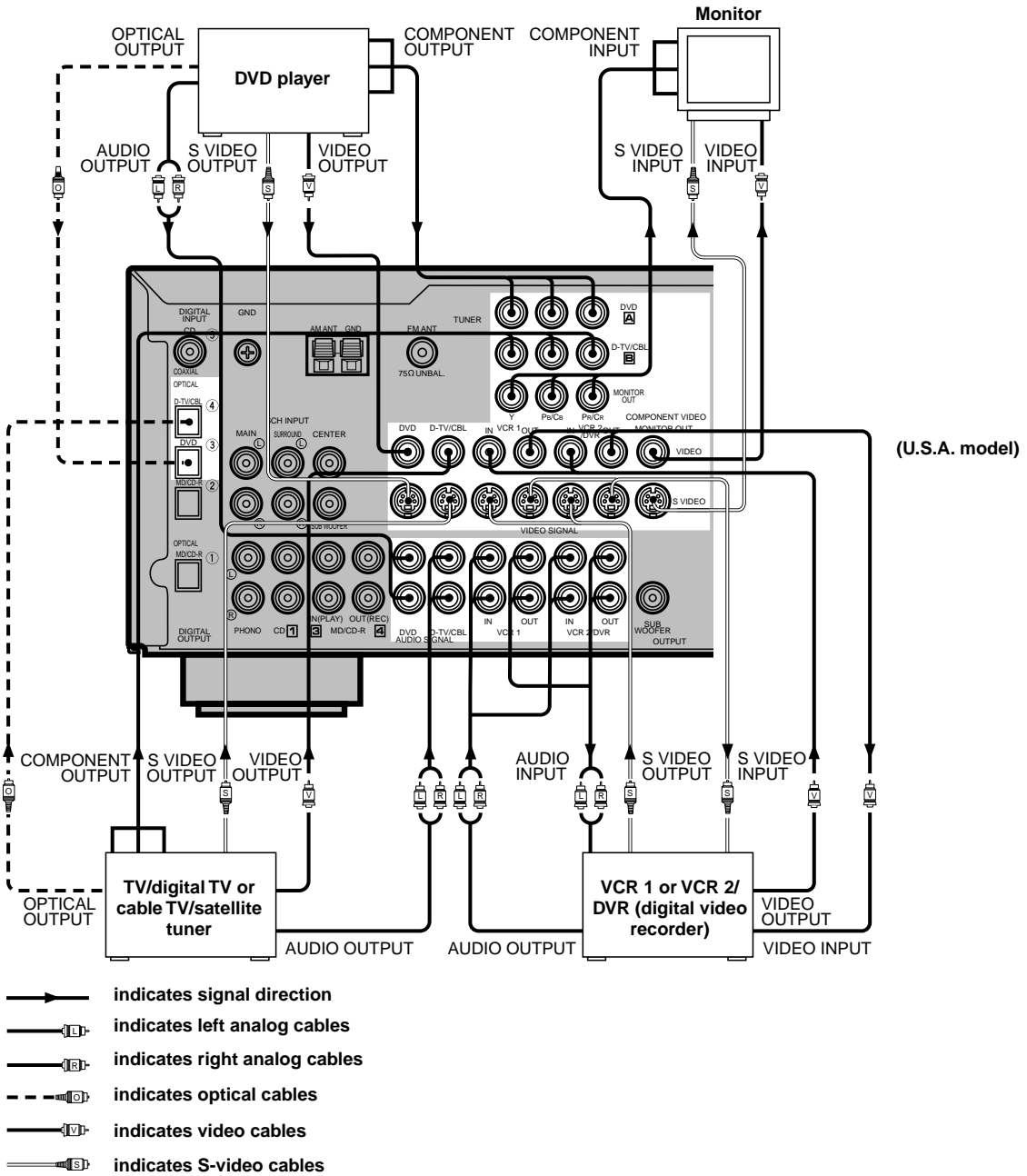

**When using an LD player**

Connect the LD player output to the DVD jack.

If the LD player has an OPTICAL digital output jack, connect it to this unit's OPTICAL DVD jack. If it has analog jacks, connect it to the analog DVD jacks. If it has an "RF OUTPUT jack" to output a Dolby Digital RF signal (AC-3), use a commercially available RF demodulator and connect it to the OPTICAL DVD jack.

If connecting a DVD player and an LD player, connect the LD player to the digital input jack (ex. D-TV/CBL) or the analog input jack (D-TV/CBL, VCR 1 or VCR 2/DVR). For details on connections and operations, refer to the instruction manual for the LD player.

Note that this unit's remote control can be used to operate the LD player by setting the corresponding manufacturer code for the DVD/LD position.

PREPARATION

English

## Connecting the Speakers

Be sure to connect the left channel (L), right channel (R), “+” (red) and “-” (black) properly. If the connections are faulty, no sound will be heard from the speakers, and if the polarity of the speaker connections is incorrect, the sound will be unnatural and lack bass.

### CAUTION

- Use speakers with the specified impedance shown on the rear panel of this unit.
- Do not let the bare speaker wires touch each other and do not let them touch any metal part of this unit. This could damage the unit and/or speakers.

If necessary, use the SET MENU to change the speaker mode settings according to the number and size of the speakers in your configuration after you finish connecting your speakers.

### ■ Speaker cables

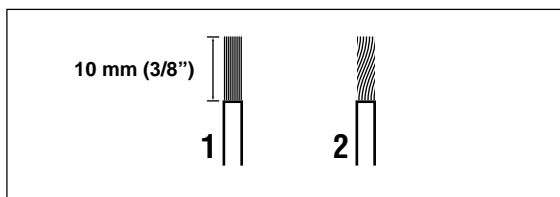

A speaker cord is actually a pair of insulated cables running side by side. One of the cables is colored or shaped differently, perhaps with a stripe, groove or ridge.

- 1** Remove approx. 10 mm (3/8”) of insulation from each of the speaker cables.
- 2** Twist the exposed wires of the cable together to prevent short circuits.

### ■ Connecting to the SPEAKERS terminals

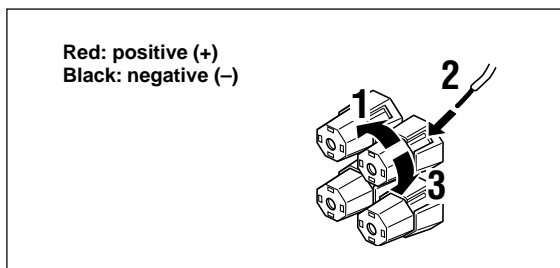

Red: positive (+)  
Black: negative (-)

- 1** Unscrew the knob.
- 2** Insert one bare wire into the hole in the side of each terminal.
- 3** Tighten the knob to secure the wire.

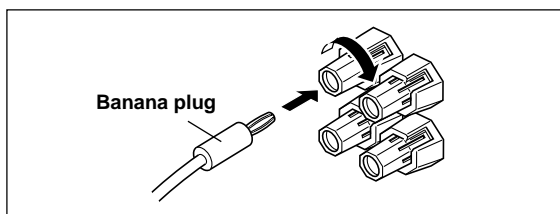

(U.S.A., Canada, Australia, China and General models only)

- Banana plug connections are also possible. First, tighten the knob and then insert the banana plug connector into the end of the corresponding terminal.

### ■ MAIN SPEAKERS terminals

One or two speaker systems can be connected to these terminals. If you use only one speaker system, connect it to either of the MAIN A or B terminals.

### ■ REAR SPEAKERS terminals

A rear speaker system can be connected to these terminals.

### ■ CENTER SPEAKER terminals

A center speaker can be connected to these terminals.

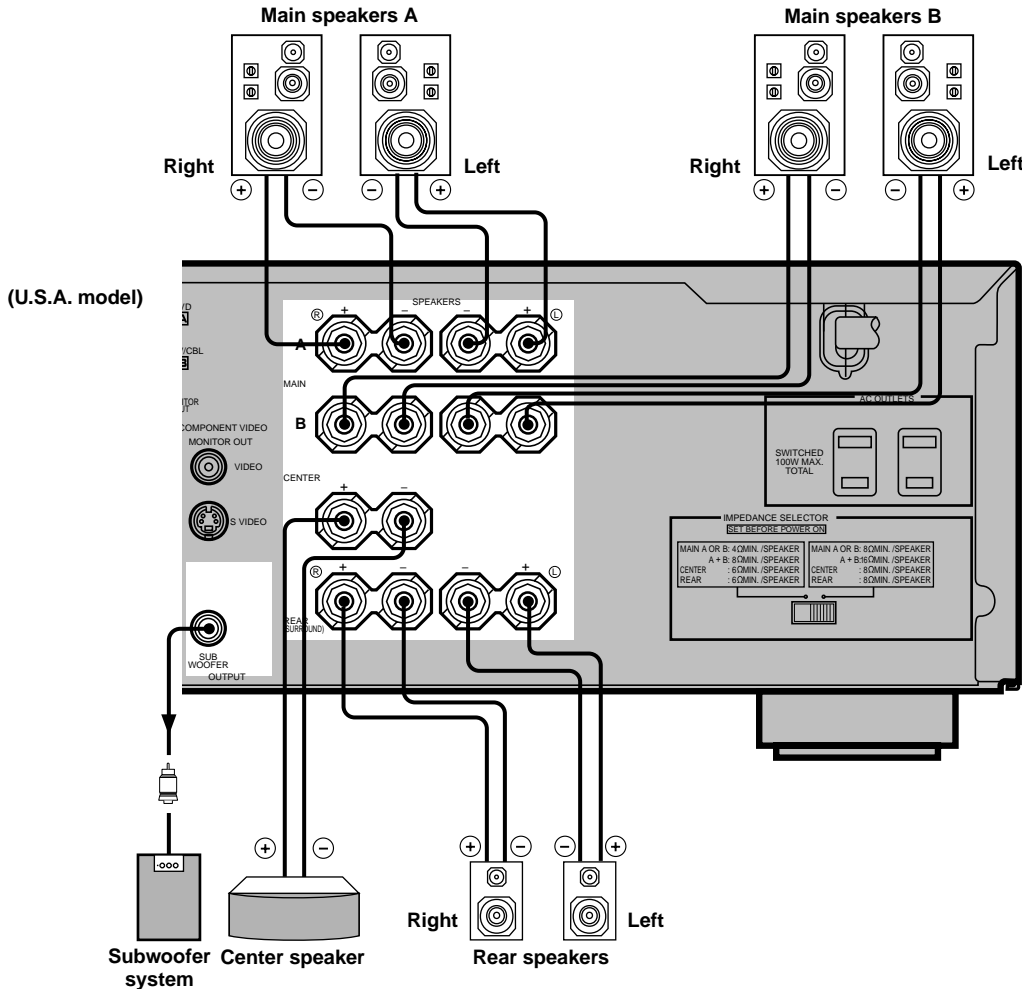

## ■ SUBWOOFER jack

When using a subwoofer with built-in amplifier, including the YAMAHA Active Servo Processing Subwoofer System, connect the input jack of the subwoofer system to this jack. Low bass signals distributed from the main, center and/or rear channels are directed to this jack. (The cut-off frequency of this jack is 90 Hz.) The LFE (low-frequency effect) signals generated when Dolby Digital or DTS is decoded are also directed if they are assigned to this jack.

### Notes

- Adjust the subwoofer volume according to the operating instructions for the subwoofer. (Fine adjustment is possible using this unit's output level control of the effect speakers.)
- Depending on the settings of "1 SPEAKER SET", "6 DOLBY D. SET" and "7 DTS SET" on the SET MENU, some signals may not be output from the SUBWOOFER jack.

# IMPEDANCE SELECTOR Switch

**WARNING**

Do not change the IMPEDANCE SELECTOR switch setting while the power of this unit is on, otherwise the unit may be damaged.  
 If this unit fails to turn on when STANDBY/ON (or POWER) is pressed, the IMPEDANCE SELECTOR switch may not be fully slid to either position. If so, slide the switch to either position fully when this unit is in the standby mode.

Select the left or right position according to the impedance of the speakers in your system. Be sure to move this switch only when this unit is in the standby mode.

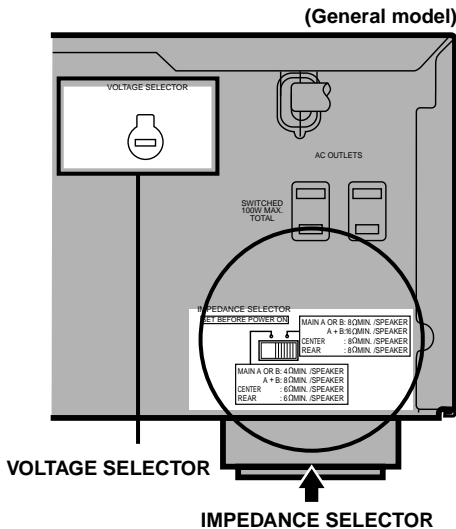

Switch position	Speaker	Impedance level
Left	Main	If you use one set of main speakers, the impedance of each speaker must be 4 Ω or higher. If you use two sets of main speakers, the impedance of each speaker must be 8 W or higher.
	Center	The impedance must be 6 Ω or higher.
	Rear	The impedance of each speaker must be 6 Ω or higher.
Right	Main	If you use one set of main speakers, the impedance of each speaker must be 8 Ω or higher. If you use two sets of main speakers, the impedance of each speaker must be 16 W or higher. [Canada model only] The impedance of each speaker must be 8 W or higher.
		Center
	Rear	The impedance of each speaker must be 8 Ω or higher.

■ **VOLTAGE SELECTOR (China and General models only)**

The VOLTAGE SELECTOR on the rear panel of this unit must be set for your local main voltage BEFORE plugging into the AC main supply. Voltages are 110/120/220/240 V AC, 50/60 Hz.

## Connecting the Power Supply Cords

After completing all connections, connect the AC power cord to an AC power outlet. Disconnect the AC power cord if you will not use this unit for a long period of time.

■ **AC OUTLET(S) (SWITCHED)**

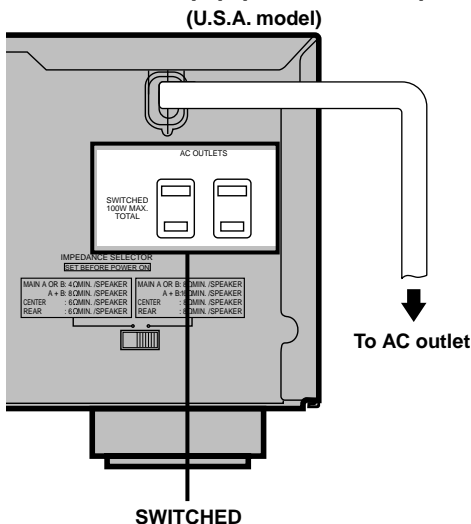

U.S.A., Canada, Singapore, China and General models ..... 2 OUTLETS  
 Australia model ..... 1 OUTLET  
 Use these outlets to connect the power cords only from your audio/video components to this unit. The power to the AC OUTLET(S) is controlled by this unit's STANDBY/ON (or POWER and STANDBY). These outlets will supply power to any connected component whenever this unit is turned on. The maximum power (total power consumption of components) that can be connected to the AC OUTLET(S) is 100 W.

# ON-SCREEN DISPLAY (OSD)

You can display the operation information for this unit on a video monitor. If you display the SET MENU and DSP program parameter settings on a monitor, it is much easier to see the available options and parameters than it is by reading this information on the front panel display.



- If a video source is being reproduced, the OSD is superimposed over the image.
- The OSD signal is not output to the REC OUT jack, and will not be recorded with any video signal.
- You can set the OSD to turn on (blue background) or off when a video source is not being reproduced (or the source component is turned off) by using “9 DISPLAY SET” on the SET MENU.

## OSD Modes

You can change the amount of information the OSD shows.

### Full display

This mode always shows the DSP program parameter settings on the video monitor.

### Short display

This mode briefly shows the same contents as the front panel display at the bottom of the screen and then disappears.

### Display off

This mode briefly shows the “DISPLAY OFF” message at the bottom of the screen and then disappears. Afterwards, no changes to operations appear on the monitor except those of the ON SCREEN button.

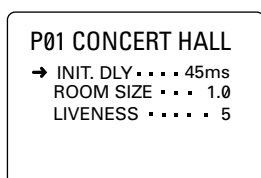

Full display

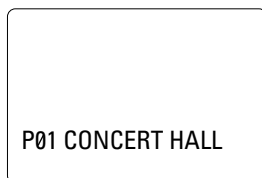

Short display



- When you choose the full display mode, INPUT </>, VOLUME and some other types of operation information are displayed at the bottom of the screen in the same format as that for the front panel display.
- The SET MENU and test tone display appear regardless of the OSD mode.

## Selecting the OSD Mode

- 1** When you turn on the power, the video monitor and front panel display show the level of the main volume for a few seconds and then switch to show the current DSP program.

- 2** Press ON SCREEN on the remote control repeatedly to change the display mode. The OSD mode changes in the following order: full display, short display, and display off.

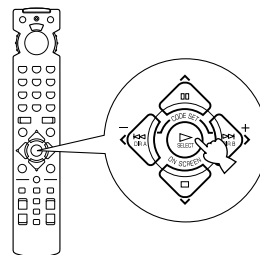

### Notes

- If you choose a video input source that has a component connected to both the S VIDEO IN and composite VIDEO IN jacks, and both the S VIDEO OUT and composite VIDEO OUT jacks are connected to a video monitor, the video signal is output to both the S VIDEO OUT and VIDEO OUT jacks. However, the OSD is carried only on the S-video signal. If no video signal is input, the OSD is carried on both the S-video and composite video signals.
- If your video monitor is connected only to the COMPONENT VIDEO jacks of this unit, the OSD is not shown. Make sure to connect your video monitor to the COMPONENT VIDEO jacks and either VIDEO or S VIDEO jacks if you want to see the OSD.
- Playing back video software that has an anti-copy signal or video signals with a lot of noise may produce unstable images.

## SPEAKER MODE SETTINGS

This unit is equipped with a main amplifier capable of handling 5.1 channel. Although up to 6 speakers can be connected, it is possible to select the speaker mode that gives the best sound field effect according to the number and size of speakers being used.

Before use, please set the speaker mode setting using “1 SPEAKER SET” on the SET MENU described on page 36.

### *Summary of SPEAKER SET Items 1A through 1E*

Item	Description	Control value (default setting indicated in bold)
<b>1A CENTER SP</b>	Selects the output mode according to whether or not a center speaker is being used and its performance.	<b>LRG</b> /SML/NONE
<b>1B MAIN SP</b>	Selects the output mode according to the performance of the main speakers.	<b>LARGE</b> /SMALL
<b>1C REAR L/R SP</b>	Selects the output mode according to whether or not rear L/R speakers are being used and their performance.	<b>LRG</b> /SML/NONE
<b>1D LFE/BASS OUT</b>	Selects the speaker according to use for LFE signal output and low bass signal.	SWFR/ <b>MAIN</b> /BOTH
<b>1E MAIN LEVEL</b>	Selects the main speaker level.	<b>Normal</b> /-10 dB



# ADJUSTING THE SPEAKER OUTPUT LEVELS

This section explains how to adjust the speaker output levels by using the test tone generator. When this adjustment is made, the output level heard at the listening position will be the same from each speaker. This is important for the best performance of the digital sound field processor, the Dolby Pro Logic decoder, Dolby Digital decoder and DTS decoder.

## Note

- Since this unit cannot enter the test mode while headphones are connected to this unit, be sure to unplug the headphones from the PHONES jack when using the test tone.

## Before You Begin

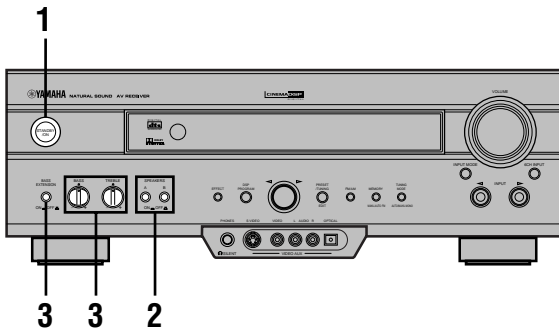

- 1 Press **STANDBY/ON** to turn on the power. Turn on the video monitor.



- 2 Press **SPEAKERS A** or **B** to select the main speakers to be used.

If you are using two sets of the main speakers, press both A and B.

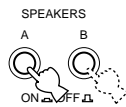

- 3 Set **BASS** and **TREBLE** on the front panel to the center position and set **BASS EXTENSION** to OFF.

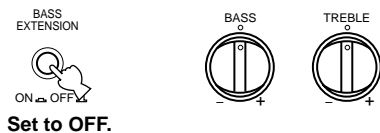

## Using the Test Tone (TEST DOLBY SUR.)

The adjustment of each speaker output level should be made at your listening position with the remote control.

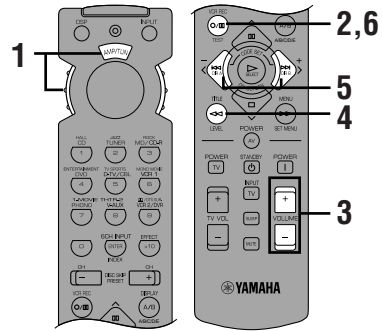

- 1 Set the selector dial to the **AMP/TUN** (or **DSP/TUN**) position.



- 2 Press **TEST** to output the test tone.



- 3 Adjust the volume so you can hear the test tone.

The test tone is heard from the left main speaker, center speaker, right main speaker and right rear speaker in order. The tone is produced for 2.5 seconds each time.

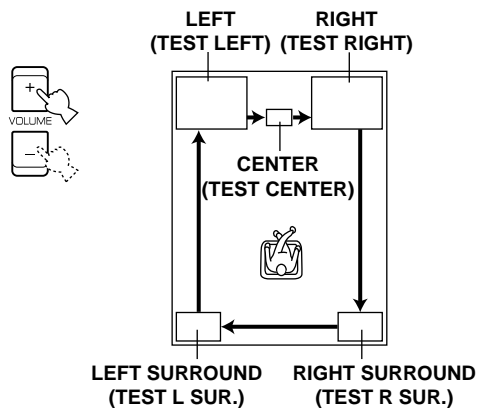

The state of the test tone output is also shown on the monitor by an image of the audio listening room. This is convenient for adjusting each speaker level.

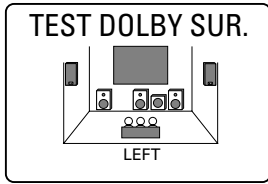

- If “1A CENTER SP” on the SET MENU is set to NONE, the center channel sound is automatically output from the left and right main speakers.

**Note**

- If the test tone cannot be heard, turn down the volume, set the unit in the standby mode and check the speaker connections.

**4 Press LEVEL repeatedly to select the speaker to be adjusted.**



- Once you press LEVEL, you can also select the speaker to be adjusted by pressing ∨. (Pressing ∧ changes the selection in the reverse order.)

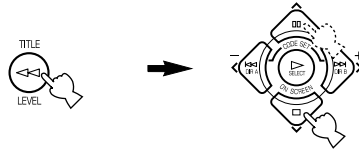

**5 Press </> repeatedly to adjust the output level of the currently selected speaker so that it becomes almost the same as that of the main speaker.**

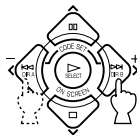

- While adjusting, the test tone is heard from the selected speaker.
- Repeat steps 4 and 5 to adjust the output levels of the center, left rear and right rear speakers.

**6 When the adjustment is complete, press TEST.**

The test tone stops and the current DSP program appears on the front panel display and on the video monitor.



**Notes**

- For details on adjusting the subwoofer speaker, see the effect speaker level adjustment described on page 42.
- After adjusting with the test tone, it is possible to adjust the speaker level to taste while listening to the playback of an actual source when using the effect speaker level adjustment described on page 42.



- You can increase the output levels of the effect speakers (center, left rear and right rear) to +10 dB. If the output level of these speakers is lower than that of the main speakers even after you have increased the output level of these speakers up to +10 dB, set “1E MAIN LEVEL” on the SET MENU to -10 dB. This setting decreases the main speaker output level to about one-third of the normal level. After you have set “1E MAIN LEVEL” on the SET MENU to -10 dB, adjust the levels for the center and rear speakers again.

# BASIC PLAYBACK

When using the remote control, set the selector dial to the AMP/TUN position.

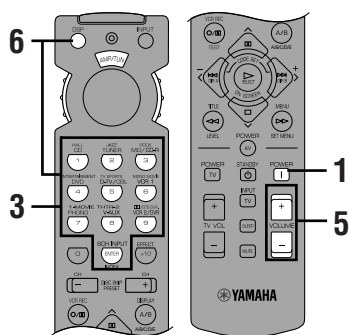
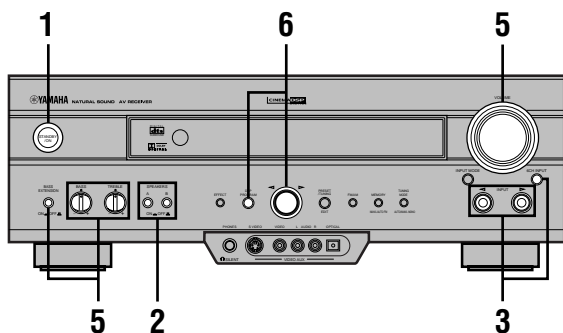

**3** Press **INPUT** </> repeatedly (or press one of the input selector buttons) to select the input source.

- The current input source is indicated on the front panel display with a cursor.
- The current input source name and input mode appear on the front panel display and on the video monitor for a few seconds.

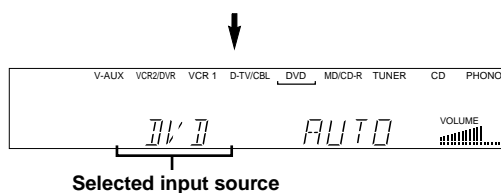
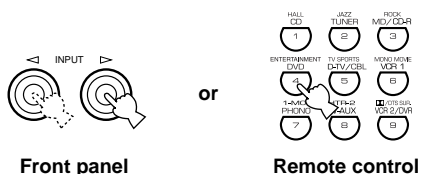

Selected input source

**Select this:**      **To reproduce the signal from this component**

- |            |   |
|------------|---|
| PHONO:     | Turntable   |
| CD:        | CD player   |
| TUNER:     | AM/FM tuner   |
| MD/CD-R:   | MD recorder/CD recorder/tape deck   |
| DVD:       | DVD player  |
| D-TV/CBL:  | TV/digital TV or cable TV/satellite tuner   |
| VCR 1:     | Video cassette deck 1   |
| VCR 2/DVR: | Video cassette deck 2/digital video recorder  |
| V-AUX:     | Another audio/video component (connected to the VIDEO AUX jacks on the front panel) |

**1** Press **STANDBY/ON** (or **POWER**) to turn on the power. Turn on the video monitor.

The front panel display and the video monitor show the level of the main volume for a few seconds and then switch to show the current DSP program.

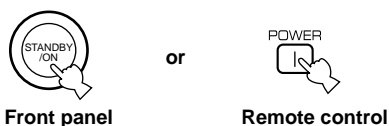

**2** Press **SPEAKERS A** or **B** to select the main speakers to be used.

If you are using two sets of main speakers, press both A and B.

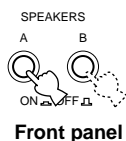

**To select a source connected to the 6CH INPUT jacks**

Press 6CH INPUT until “6CH INPUT” appears on the front panel display and on the video monitor.

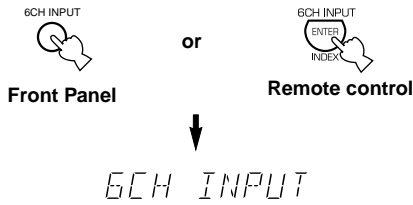

**Notes**

- If “6CH INPUT” is shown on the front panel display and on the video monitor, no other source can be played. To select another input source with INPUT ◀/▶ (or the input selector buttons), press 6CH INPUT to turn off “6CH INPUT” from the front panel display and the video monitor.
- If you want to enjoy an audio source connected to the 6CH INPUT jacks together with a video source, first select the video source and then press 6CH INPUT.

**4 Start playback (or select a broadcast station) on the source component.**

Refer to the operation instructions for the component.

**5 Adjust the volume to the desired output level.**

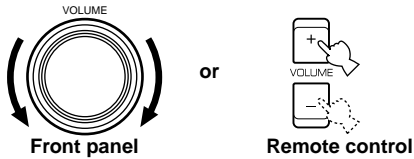

If desired, use BASS, TREBLE and BASS EXTENSION etc. These controls are only effective for sound from the main speakers.

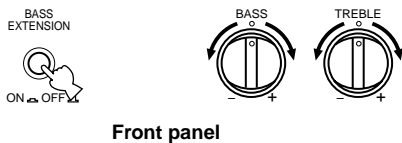

**Note**

- If the component connected to the VCR 1 OUT, VCR 2/DVR OUT and MD/CD-R OUT jacks is turned off, the reproduced sound may be distorted or the volume may be lowered. In these cases, turn on the component.

**6 Use the digital sound field processor.**

See “Selecting a Sound Field Program”.

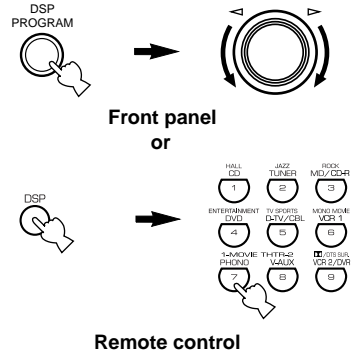

**To mute the sound**

Use this when you want to temporarily mute audio output.

Press **MUTE** on the remote control.



To restore the audio output to the previous volume level, press MUTE again.



- You can also cancel mute to press any operation buttons such as VOLUME +/-.
- During muting, “MUTE ON” appears on the front panel display and on the video monitor.

**When you have finished using this unit**

Press **STANDBY/ON** (or **STANDBY**) to set this unit in the standby mode.

**Notes on the digital signal**

The digital input jacks of this unit can also handle 96-kHz sampling digital signals. (To utilize this, use a source that supports 96-kHz sampling digital signals and set the player for digital output. Refer to the operation instructions for the player.) Note the following when a 96-kHz sampling digital signal is input to this unit:

1. The following indication will appear on the front panel display.

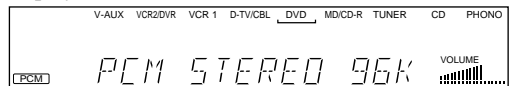

2. DSP programs cannot be selected. Sound will be output as normal 2-channel stereo sound from only the left and right main speakers.

**Note**

- If “1B MAIN SP” on the SET MENU is set to SMALL and “1D LFE/BASS OUT” is set to SWFR, or “1D LFE/BASS OUT” is set to BOTH, the sound is also output from the subwoofer.
3. Adjustment of the speaker output level described on page 42 cannot be made.

## ■ BGV (background video) function

The BGV function allows you to combine a video image from a video source with a sound from an audio source. (For example, you can listen to classical music while you are watching a video.)

Select a source from the video group and then select a source from the audio group with the input selector buttons on the remote control. The BGV function does not work if you select the sources with INPUT  $\triangleleft$ / $\triangleright$  on the front panel.

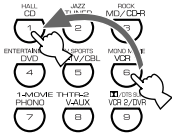

## Input Modes and Indications

When using the remote control, set the selector dial to the AMP/TUN position.

This unit comes with various input jacks. If your component is connected to more than one type of input jack, you can set the priority of the input signal.

**Press INPUT MODE (or the input selector button that you have pressed to select the input source on the remote control) repeatedly until the desired input mode is shown on the front panel display and on the video monitor.**

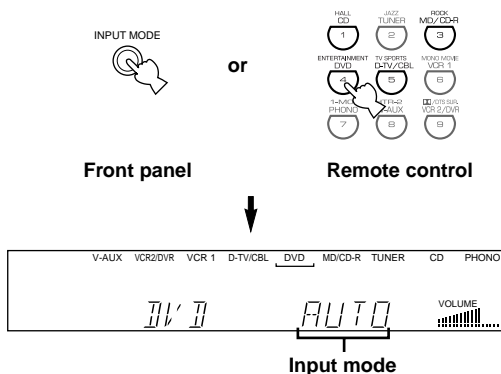

**AUTO:**

In this mode, the input signal is automatically selected in the following order:

- 1) Dolby Digital or DTS signal
- 2) Digital (PCM) signal
- 3) Analog signal

**DTS:**

In this mode, only the digital input signal encoded with DTS is selected even if another signal is input at the same time.

**ANLG (ANALOG):**

In this mode, only the analog input signal is selected even if a digital signal is input at the same time.

### Notes

- If digital signals are input from both the COAXIAL and OPTICAL jacks, the digital signal from the COAXIAL jack is selected.
- When AUTO is selected, this unit automatically determines the type of signal. If this unit detects a Dolby Digital or DTS signal, the decoder automatically switches to the appropriate setting and reproduces 5.1 channel source.
- The sound output may be interrupted for some LD players and DVD players in the following situation:  
When the input mode has been set to AUTO and a search is performed while playing the source encoded with a Dolby Digital or DTS signal, the sound may delay for a moment when playback is resumed.
- Depending on the LD player, playback may not be made when playing an LD that is not digitally recorded with the input mode set to AUTO. If this happens, set the input mode to ANALOG.

## ■ Notes on playing a source encoded with a DTS signal

- If the digital output data of the player has been processed in any way, you may not be able to perform DTS decoding even if you make a digital connection between this unit and the player.
- If you play a source encoded with a DTS signal and set the input mode to ANALOG, this unit reproduces the noise of an unprocessed DTS signal. When you want to play a DTS source, be sure to connect the source to a digital input jack and set the input mode to AUTO or DTS.
- If you switch the input mode to ANALOG while playing a source encoded with a DTS signal, this unit reproduces no sound.
- The following phenomena may occur if the input mode is set to AUTO when playing back source encoded with a DTS.
  - If you continue to play a source encoded with a DTS signal this unit automatically switches to the “DTS-decoding” mode to prevent noise from being generated during subsequent operation. (The “**dts**” indicator lights up on the front panel display.) The “**dts**” indicator may flash immediately after playback of a source encoded with a DTS signal has finished. Only a source encoded with a DTS signal can be played back while this indicator is flashing. (The indicator will flash for less than a minute.) If you want to play a normal PCM source soon, set the input mode back to AUTO.
  - The “**dts**” indicator may flash when a search or skip operation is performed. If this status continues for a certain length of time, the unit will automatically switch from the “DTS-decoding” mode to PCM digital signal input mode and the “**dts**” indicator will go out.

## Selecting a Sound Field Program

You can enhance your listening experience by selecting a DSP program. For details about each program, see “SOUND FIELD PROGRAM”.

### On the remote control

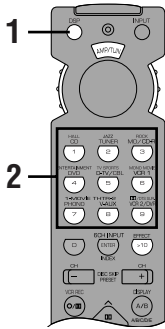

#### 1 Press DSP.

The indicator lights up for about 3 seconds.



- If the selector dial is set to the DSP/TUN position, skip this step.

#### 2 Use the numeric buttons to select the desired program before the indicator goes off.

- For example, to select the sub-program “SPECTACLE”, press MOVIE THEATER 1 repeatedly.
- The name of the selected program appears on the front panel display and on the video monitor.

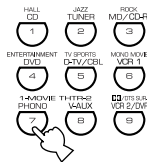

Program group

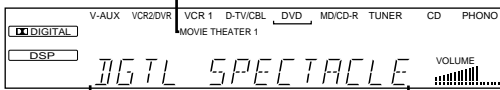

Program name (sub-program)

### On the front panel

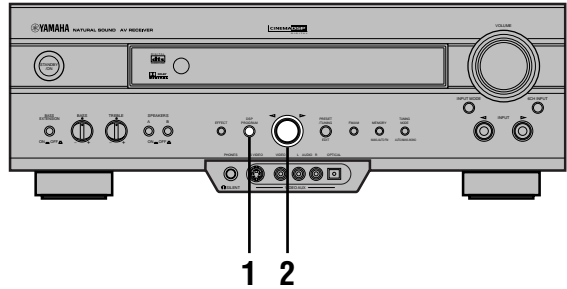

#### 1 Press DSP PROGRAM.



#### 2 Turn the multi jog knob to select the program.

The name of the selected program appears on the front panel display and on the video monitor.

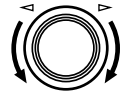

#### Notes

- Choose a DSP program based on your listening preference, and not on the name of the program. The acoustics of your listening room affect the DSP program. Minimize the sound reflections in your room to maximize the effect created by the program.
- When you select an input source, this unit automatically selects the last DSP program used with that source.
- When you set this unit in the standby mode, the current source and DSP program are memorized and are automatically selected when you turn on the power again.
- If a Dolby Digital or DTS signal is input when the input mode is set to AUTO, the DSP program automatically switches to the appropriate decoding program.
- When a monaural source is being played with PRO LOGIC/NORMAL or PRO LOGIC/ENHANCED, no sound will be heard from the main speakers and the rear speakers. Sound can only be heard from the center speaker. However, if “1A CENTER SP” on the SET MENU is set to NONE, the center channel sound is output from the main speakers.
- When a source connected to the 6CH INPUT jacks of this unit is selected, the digital sound field processor cannot be used.
- When 96-kHz sampling digital signals are input to this unit, the DSP program cannot be selected. In this case, the sound is reproduced as normal 2-channel stereo.

## ■ Virtual CINEMA DSP and SILENT CINEMA

### Virtual CINEMA DSP

Virtual CINEMA DSP allows you to enjoy the sound field effects of the DSP program without rear speakers. Using YAMAHA original technology, natural surround reproduction is possible through the generation of a virtual speaker.

The sound field processing is changed to the Virtual CINEMA DSP mode by setting "1C REAR L/R SP" on the SET MENU to NONE. Virtual CINEMA DSP is performed by using the main speakers.

#### Note

- This unit is not set in the Virtual CINEMA DSP mode even if "1C REAR L/R SP" is set to NONE in the following cases:
  - when the 5CH STEREO, PRO LOGIC/NORMAL, DOLBY DIGITAL/NORMAL or DTS/NORMAL program is selected;
  - when the sound effect is turned off;
  - when 6CH INPUT is selected as the input source;
  - when 96-kHz sampling digital signals are input to this unit;
  - when the Dolby Digital KARAOKE source is played;
  - when using the test tone; or
  - when connecting the headphones (you will hear SILENT CINEMA).

### SILENT CINEMA

SILENT CINEMA allows you to enjoy the realistic feel of the DSP program while using headphones. This feature delivers powerful surround reproduction just as if listening through the speakers.

You can listen to SILENT CINEMA by connecting your headphones to the PHONES jack while the effect speakers are on.

## Normal Stereo Reproduction

Press **EFFECT** to turn off the sound effect for normal stereo reproduction.

Press **EFFECT** again to turn the sound effect back on.

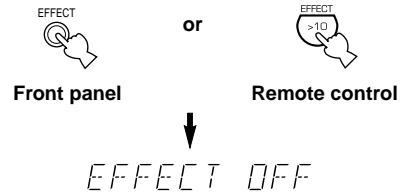

- If the selector dial is set to a position other than the DSP/TUN position, first press DSP and then EFFECT on the remote control.

#### Notes

- If you turn off the sound effect, no sound is output from the center and rear speakers.
- If you turn off the sound effect while a Dolby Digital or DTS signal is being output, the dynamic range of the signal is automatically compressed and the sounds of the center and rear speaker channels are mixed and output from the main speakers.
- The volume may be greatly reduced when you turn off the sound effect or if you set "6 D-RANGE" on the SET MENU to MIN. In this case turn on the sound effect.



# TUNING

## Connecting the Antennas

Both AM and FM indoor antennas are included with this unit. In general, these antennas should provide sufficient signal strength.

Connect each antenna correctly to the designated terminals.

### FREQUENCY STEP switch (China and General models only)

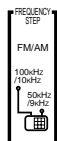

Because the interstation frequency spacing differs in different areas, set the FREQUENCY STEP switch (located at the rear) according to the frequency spacing in your area.

North, Central and South America:  
100 kHz/10 kHz

Other area: 50 kHz/9 kHz

Before setting this switch, disconnect the AC power plug of this unit from the AC outlet.

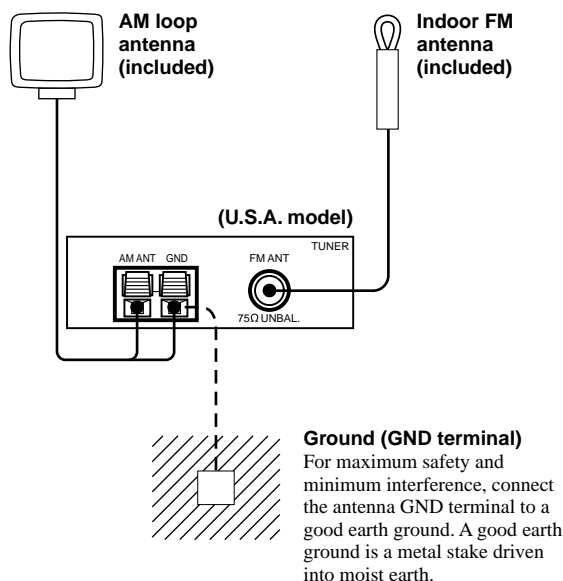

### Connecting the indoor FM antenna

Connect the included indoor FM antenna to the FM ANT 75Ω UNBAL. terminal.

#### Note

- Do not connect an outdoor FM antenna and the indoor FM antenna at the same time.

### Connecting the AM loop antenna

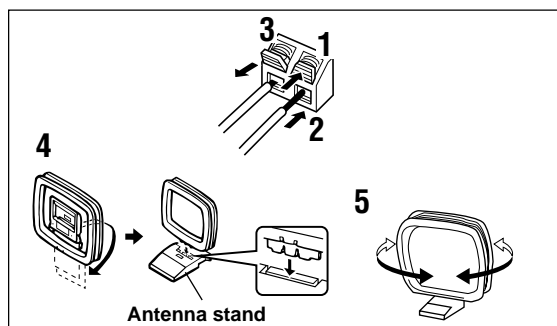

- Press and hold the tab to unlock the terminal hole.
- Insert the AM loop antenna lead wires into the AM ANT and GND terminals.
- Release the tab to lock the lead wires. Lightly pull the lead wires to confirm a good connection.
- Attach the loop antenna to the antenna stand.
- Orient the AM loop antenna so that the best reception is obtained.



- The AM loop antenna can be removed from the stand and attached to a wall, etc.

#### Notes

- The AM loop antenna should be placed away from this unit.
- The AM loop antenna should always be connected, even if an outdoor AM antenna is connected to this unit.

A properly installed outdoor antenna provides clearer reception than an indoor one. If you experience poor reception quality, an outdoor antenna may improve the quality. Consult the nearest authorized YAMAHA dealer or service center about the outdoor antennas.

## Automatic (or Manual) Tuning

Automatic tuning is effective when station signals are strong and there is no interference.

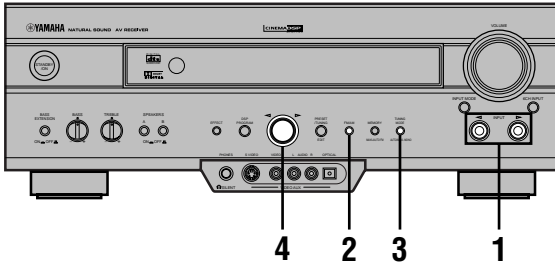

**1** Press INPUT  $\triangleleft/\triangleright$  to select TUNER as the input source.

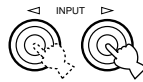

**2** Press FM/AM to select the reception band. “FM” or “AM” appears on the front panel display.

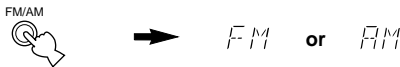

**3** Press TUNING MODE (AUTO/MAN'L MONO) so that the “AUTO” indicator lights up on the front panel display.



If “>” appears on the front panel display next to the band indication, press PRESET/TUNING (EDIT) to turn it off.

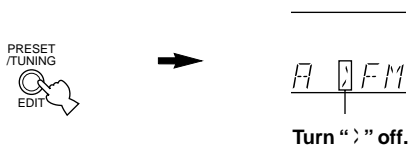

**4** Turn the multi jog knob to the right or left to begin automatic tuning.

Turn the multi jog knob to the right for tuning in to a higher frequency, or to the left for tuning in to a lower frequency. Turn the knob again if the tuning search does not stop at the desired station.

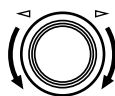

- Use the manual tuning method if the tuning search does not stop at the desired station because the signal is weak.
- When tuned in to a station, the “TUNED” indicator lights up and the frequency of the received station is shown on the front panel display.

If the signal from the station you want to select is weak, you must tune in to it manually.

**1** Press INPUT  $\triangleleft/\triangleright$  to select TUNER as the input source.

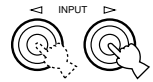

**2** Press FM/AM to select the reception band. “FM” or “AM” appears on the front panel display.

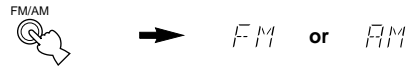

**3** Press TUNING MODE (AUTO/MAN'L MONO) so that the “AUTO” indicator goes off from the front panel display.



If “>” appears on the front panel display next to the band indication, press PRESET/TUNING (EDIT) to turn it off.

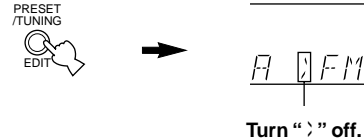

**4** Turn the multi jog knob to the right or left to tune in to the desired station manually.

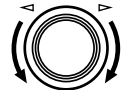

### Note

- Manually tuning in to an FM station will automatically change the reception mode to monaural to increase the signal quality.

## Presetting Stations

### Automatically presetting stations (for FM stations)

You can use the automatic preset tuning feature to store FM stations. This function enables the unit to automatically tune in to FM stations with strong signals, and to store up to 40 (8 stations x 5 groups) of those stations in order. This feature enables you to easily tune in to any preset station by selecting the preset station number (see “Tuning in to a Preset Station”).

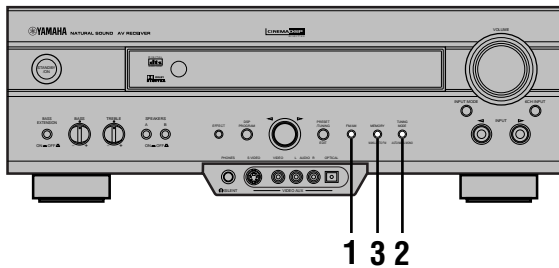

#### 1 Press FM/AM to select the FM band.



#### 2 Press TUNING MODE (AUTO/MAN'L MONO) so that the “AUTO” indicator lights up on the front panel display.



#### 3 Press and hold MEMORY (MAN'L/AUTO FM) for more than 3 seconds.

The preset number, the “MEMORY” and “AUTO” indicators flash. Then, after about 5 seconds, automatic preset tuning begins from the frequency currently displayed toward the higher frequencies.

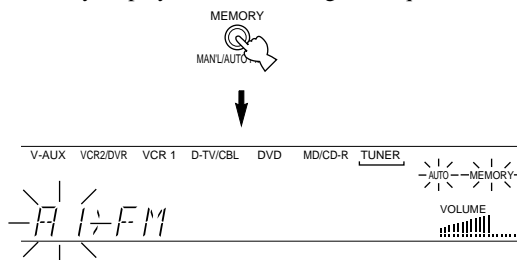

When automatic preset tuning is completed, the front panel display shows the frequency of the last preset station.

### Notes

- Any stored station data existing under a preset number is cleared when you store a new station under that preset number.
- The reception mode is stored along with the station frequency.
- You can manually replace a preset station with another FM or AM station by simply following the procedure in the section “Manually presetting stations”.
- If the number of the received stations does not reach E8, automatic preset tuning has automatically stopped after searching all stations.
- Only FM stations with sufficient signal strength are stored automatically by automatic preset tuning. If the station you want to store is weak in signal strength, tune in to it manually in the monaural mode, and store it by following the procedure in “Manually presetting stations”.

### Automatic preset tuning options

You can select the preset number from which the unit will store FM stations and/or begin tuning toward lower frequencies. Before automatic preset tuning begins (after pressing MEMORY in step 3):

1. Turn the multi jog knob to select the preset number under which the first station will be stored. Automatic preset tuning will stop when stations have all been stored up to E8.
2. Press PRESET/TUNING (EDIT) to turn off “>” and then turn the multi jog knob to the left to begin tuning toward lower frequencies.

### Memory back-up

The memory back-up circuit prevents the stored data from being lost even if this unit is set in the standby mode, the power cord is disconnected from the AC outlet, or the power supply is temporarily cut due to power failure. However, if the power is cut for more than one week, the preset stations may be cleared. If so, store the stations again by using the presetting station methods.

## Manually presetting stations

You can also store up to 40 stations (8 stations x 5 groups) manually.

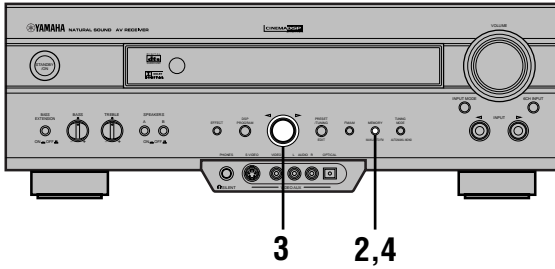

### 1 Tune in to a station.

See “Automatic (or Manual) Tuning” for tuning instructions.

### 2 Press MEMORY (MAN'L/AUTO FM).

The “MEMORY” indicator flashes for about 5 seconds.

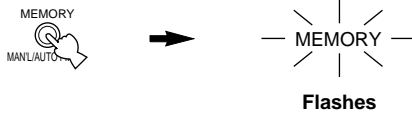

### 3 Turn the multi jog knob to select a preset station number while the “MEMORY” indicator is flashing.

Turn the multi jog knob to the right to select a higher preset station number, and to the left to select a lower preset station number.

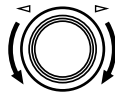

### 4 Press MEMORY (MAN'L/AUTO FM) while the “MEMORY” indicator is flashing.

The station band and frequency appear on the front panel display with the preset group and number you have selected.

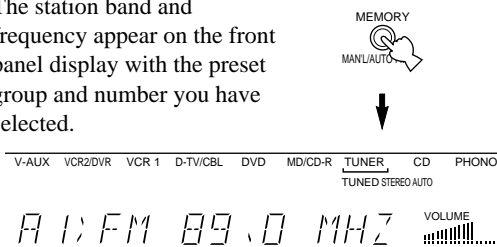

Shows the displayed station has been stored as A1.

### 5 Repeat steps 1 to 4 to store other stations.

#### Notes

- Any stored station data existing under a preset number is cleared when you store a new station under that preset number.
- The reception mode is stored along with the station frequency.

## Tuning in to a Preset Station

You can tune any desired station simply by selecting the preset station number under which it was stored.

### On the remote control

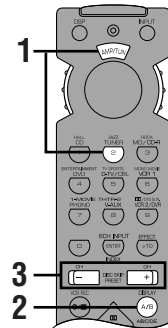

### 1 Set the selector dial to the AMP/TUN position and press TUNER to select TUNER as the input source.

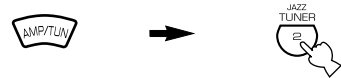

### 2 Press A/B/C/D/E to select the preset station group.

The preset group letter appears on the front panel display and changes each time you press A/B/C/D/E.



### 3 Press PRESET +/- to select a preset station number (1 to 8).

The preset group and number appear on the front panel display along with the station band, frequency and the “TUNED” indicator lights up.

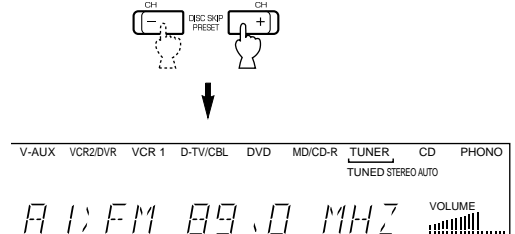

- You can select the preset station number with the numeric buttons (1 to 8) if code number “0023” has been set up in the AMP/TUN (or DSP/TUN) position.

■ On the front panel

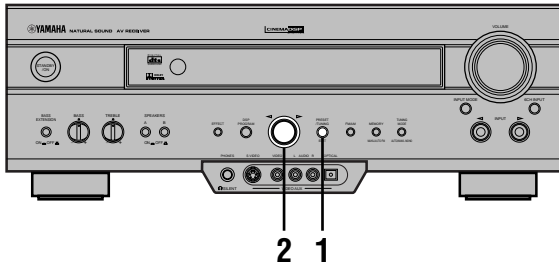

**1** Press PRESET/TUNING (EDIT) so that “`” next to the band indicator appears.



**2** Turn the multi jog knob to select the desired preset station number.

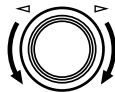

The preset group and number appear on the front panel display along with the station band, frequency, and the “TUNED” indicator lights up.

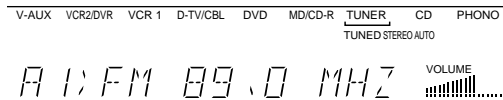

**Exchanging Preset Stations**

You can exchange the assignment of two preset stations with each other. The example below describes the procedure for exchanging preset station “E1” with “A5”.

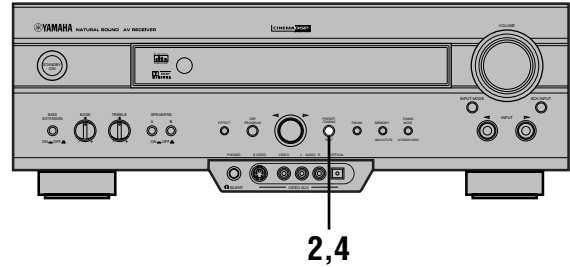

**1** Tune in to preset station “E1”.

See “Tuning in to a Preset Station”.

**2** Press and hold PRESET/TUNING (EDIT) for more than 3 seconds.

“E1” and the “MEMORY” indicator flash on the front panel display.

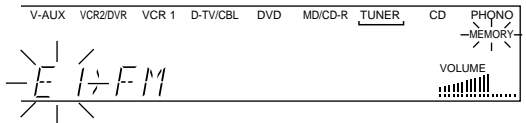

**3** Tune in to preset station “A5” by using the buttons on the front panel.

“A5” and the “MEMORY” indicator flash on the front panel display.

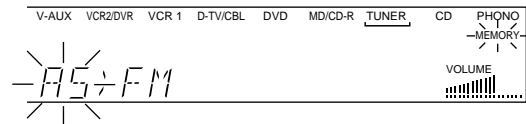

**4** Press PRESET/TUNING (EDIT) again.

The stations stored at the two preset assignments are exchanged.

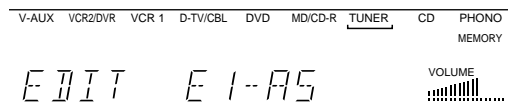

Shows the exchange of stations has been completed.

# BASIC RECORDING

Recording adjustments and other operations are performed from the recording components. Refer to the operation instructions for these components.

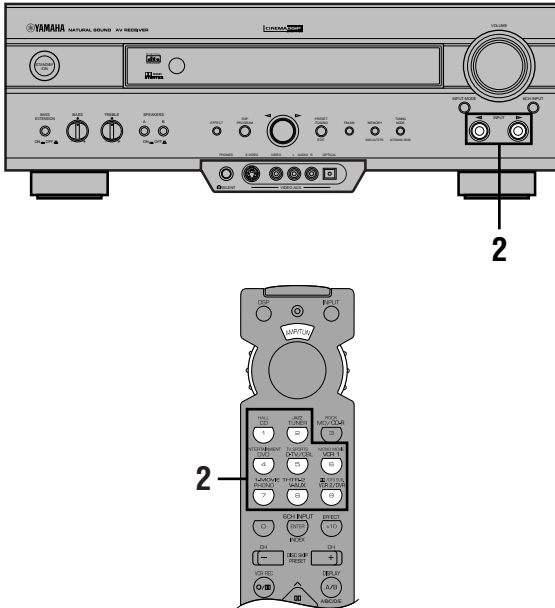

**1** Turn on the power to the unit and all connected component.

**2** Select the source component you want to record from.

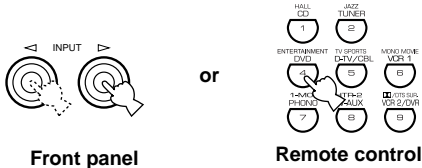

**3** Start playback (or select a broadcast station) on the source component.

**4** Start recording on the recording component.

## Notes

- Do a test recording before you start an actual recording.
- When this unit is set in the standby mode, you cannot record between other components connected to this unit.
- The setting of BASS, TREBLE, BASS EXTENSION, VOLUME, "2 L/R BALANCE" on the SET MENU and DSP programs does not affect the recorded material.
- A source connected to the 6CH INPUT jacks of this unit cannot be recorded.
- S-video and composite video signals pass independently through this unit's video circuits. Therefore, when recording or dubbing video signals, if your video source component is connected to provide only an S-video (or only a composite video) signal, you can record only an S-video (or only a composite video) signal by your VCR.
- A given input source is not output on the same REC OUT channel. (For example, the signal input from VCR 1 IN is not output on VCR 1 OUT.)
- Check the copyright laws in your country to record from records, CDs, radio, etc. Recording of copyrighted material may infringe copyright laws.

If you playback a video source that uses scrambled or encoded signals to prevent it from being dubbed, the picture itself may be disturbed due to those signals.

## Special considerations when recording DTS software

The DTS signal is a digital bitstream. Attempting to digitally record the DTS bitstream will result in noise being recorded. Therefore, if you want to use this unit to record sources that have DTS signals recorded on them, the following considerations and adjustments need to be made.

### For DVDs and CDs encoded with DTS

Only 2-channel analog audio signals may be recorded. Set the DVD player (or CD player) as described in the player's operation instructions so that the audio signals are output from the player's analog outputs.

# SET MENU

The SET MENU consists of 10 items including the speaker mode setting features. Use the SET MENU to enjoy the optimum audio/video playback for your system.



- You can adjust the items on the SET MENU while playing a source.
- We recommend that you adjust the items on the SET MENU while using a video monitor. It is easier to see the video monitor than it is to see the front panel display on this unit while adjusting the items.

## Note

- The indication on the front panel display is the abbreviation of the OSD.

### 1 SPEAKER SET

- 1A CENTER SP
- 1B MAIN SP
- 1C REAR L/R SP
- 1D LFE/BASS OUT
- 1E MAIN LEVEL

### 2 L/R BALANCE

### 3 HP TONE CTRL

### 4 I/O ASSIGNMENT

- 4A CMPNT-V INPUT
- 4B OPTICAL OUT
- 4C OPTICAL IN
- 4D COAXIAL IN

### 5 INPUT MODE

### 6 DOLBY D. SET

- LFE LEVEL
- D-RANGE

### 7 DTS SET

### 8 SP DELAY TIME

### 9 DISPLAY SET

- BLUE BACK
- OSD SHIFT
- DIMMER

### 10 MEMORY GUARD

## Adjusting the Items on the SET MENU

Adjustment should be made with the remote control.

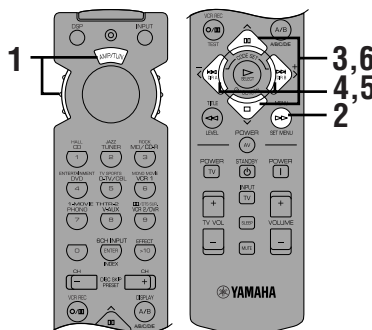

## Note

- Some items require extra steps to change to the desired setting.

**1** Set the selector dial to the AMP/TUN (or DSP/TUN) position.



**2** Press SET MENU to enter the SET MENU.



### SET MENU 1/3

- 1 SPEAKER SET
- 2 L/R BALANCE
- 3 HP TONE CTRL
- 4 I/O ASSIGNMENT
- ▲/▼ : Up/Down
- /+ : Enter

**3** Press repeatedly to select the item (1 to 10) you want to adjust.

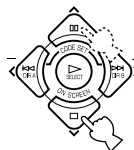

### SET MENU 1/3

- 1 SPEAKER SET
- 2 L/R BALANCE
- 3 HP TONE CTRL
- 4 I/O ASSIGNMENT
- ▲/▼ : Up/Down
- /+ : Enter



- By pressing SET MENU repeatedly, you can select items in the same order as when pressing .

**4** Press < or > once to enter the setup mode of the selected item.

The last setting you adjusted appears on the video monitor or on the front panel display.

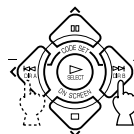

### 4A CMPNT-V INPUT

- [A]..... DVD
- [B]..... D-TV/CBL

Depending on the item, press  $\wedge/\vee$  to select a sub item.

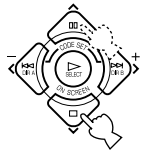

**4B OPTICAL OUT**

→ (1) ..... MD/CD-R

**5** Press  $\langle / \rangle$  repeatedly to change the setting of the item.

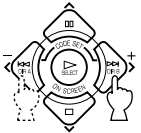

**4A CMPNT-V INPUT**

→ [A] ..... VCR 1  
[B] ..... D-TV/CBL

**6** Press  $\wedge/\vee$  repeatedly until the current DSP program appears or simply press one of the DSP program group button to exit from the SET MENU.

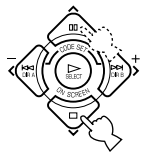

or

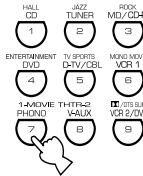

**Memory back-up**

The memory back-up circuit prevents the stored data from being lost even if this unit is set in the standby mode, the power cord is disconnected from the AC outlet, or the power supply is temporarily cut due to power failure. However, if the power is cut for more than one week, the settings of the SET MENU you adjusted will return to the factory settings. If so, adjust the items again.

**1 SPEAKER SET (speaker mode settings)**

Use this feature to select suitable output modes for your speaker configuration.

**Notes**

- When 96-kHz sampling digital signals are input to this unit, level adjustments in items 1B and 1D are possible, but those in items 1A, 1C and 1E are not affected.
- When 6CH INPUT is selected as the input source, level adjustments in items 1A through 1E are not affected.

**1A CENTER SP (center speaker mode)**

By adding a center speaker to your speaker configuration, the unit can provide good dialog localization for many listeners and superior synchronization of sound and images. The OSD shows a large, small or no center speaker depending on how you set this item.

Choices: LRG (large), SML (small), NONE

Initial setting: LRG

**LRG**

Select this if you have a large center speaker. The entire range of the center channel signal is directed to the center speaker.

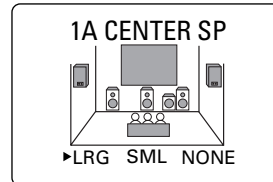

**SML**

Select this if you have a small center speaker. The low-frequency signals (90 Hz and below) of the center channel are directed to the speakers selected with "1D LFE/BASS OUT".

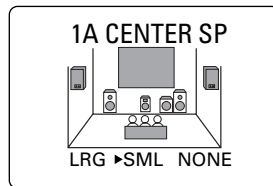



**NONE**

Select this if you do not have a center speaker. All of the center channel signals are directed to the left and right main speakers.

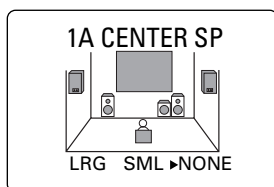
**1B MAIN SP (main speaker mode)**

The OSD shows large or small main speakers depending on how you set this item.

Choices: LARGE, SMALL

Initial setting: LARGE

**LARGE**

Select this if you have large main speakers. The entire range of the left and right main channel signal is directed to the left and right main speakers.

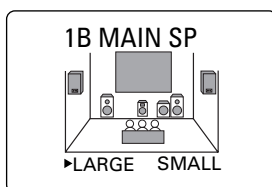
**SMALL**

Select this if you have small main speakers. The low-frequency signals (90 Hz and below) of the main channel are directed to the speakers selected with "1D LFE/BASS OUT".

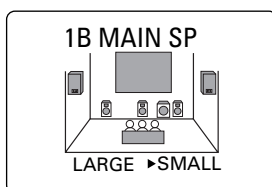
**Note**

- When you select MAIN for "1D LFE/BASS OUT", the low-frequency signals (90 Hz and below) of the main channel are directed to the main speakers even if you select SMALL for the main speaker mode.

**1C REAR L/R SP (rear speaker mode)**

The OSD shows large, small or no rear speakers depending on how you set this item.

Choices: LRG (large), SML (small), NONE

Initial setting: LRG

**LRG**

Select this if you have large left and right rear speakers or if a rear subwoofer is connected to the rear speakers. The entire range of the rear channel signal is directed to the left and right rear speakers.

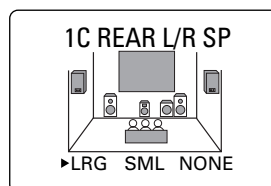
**SML**

Select this if you have small left and right rear speakers. The low-frequency signals (90 Hz and below) of the rear channel are directed to the speakers selected with "1D LFE/BASS OUT".

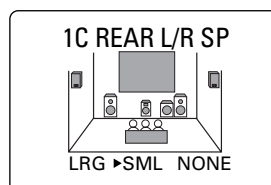
**NONE**

Select this if you do not have rear speakers.

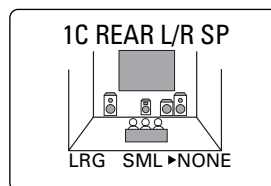

- This unit is set in the Virtual CINEMA DSP mode by selecting NONE for "1C REAR L/R SP".

## ■ 1D LFE/BASS OUT (bass out mode)

LFE signals carry low-frequency effects when this unit decodes a Dolby Digital or DTS signal. Low-frequency signals are defined as 90 Hz and below.

Choices: SWFR (subwoofer), MAIN, BOTH  
Initial setting: BOTH

### SWFR

Select this if you use a subwoofer. The LFE signals are directed to the subwoofer.

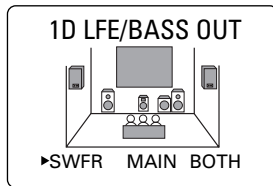

### MAIN

Select this if you do not use a subwoofer. The LFE signals are directed to the main speakers.

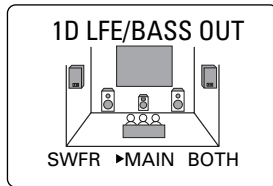

### BOTH

Select this if you use a subwoofer and you want to mix the main channel low-frequency signals with the LFE signals.

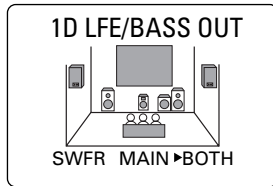

### Notes

- When playing a 2-channel source (CD, MD, tape, video cassette etc.), select the BOTH position to direct low bass signals (below 90 Hz) to the SUBWOOFER jack.
- When you select SMALL (SML) for items 1A, 1B and 1C, the low-frequency signals (90 Hz and below) from those channels are added to the LFE and output to the subwoofer.

## ■ 1E MAIN LEVEL (main level mode)

Change this setting if you cannot match the output level of the center and rear speakers with the main speakers because of the unusually high-efficiency performance of the main speakers.

Choices: Normal, -10 dB  
Initial setting: Normal

### Normal

Normally select this setting.

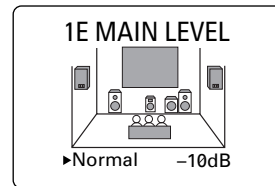

### -10 dB

Select this if you cannot match the output level of your effect speakers with that of your main speakers when using the test tone. This setting decreases the main speaker output level to about one-third of the normal level.

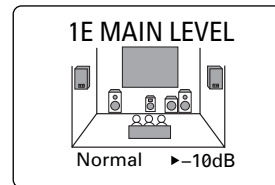

## 2 L/R BALANCE (balance of the left and right main speakers)

Use this feature to adjust the balance of the output level from the left and right main speakers.

Control range: 10 for L/R  
Initial setting: 0

**Press > to decrease the output level for the left main speaker. Press < for the right main speaker.**

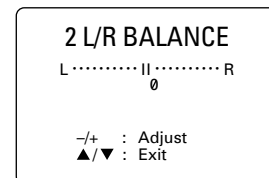

### Note

- The L/R BALANCE setting also applies to when headphones are being used.

### 3 HP TONE CTRL (headphone tone control)

Use this feature to adjust the level of the bass and treble when you use your headphones.

Control range (dB): -6 to +3

Initial setting: 0 dB for both BASS and TRBL (treble)

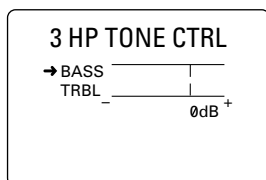

### 4 I/O ASSIGNMENT

It is possible to assign jacks according to the component to be used if this unit's COMPONENT VIDEO input jack or DIGITAL INPUT/OUTPUT jack settings (component names for jacks) differ from that component. This makes it possible to change the jack assignment and effectively connect more component.

Once you assign, you can select that component with INPUT ◀/▶ (or the input selector buttons).

#### ■ 4A CMPNT-V INPUT (for the COMPONENT VIDEO jacks)

Initial settings: [A] DVD

[B] D-TV/CBL

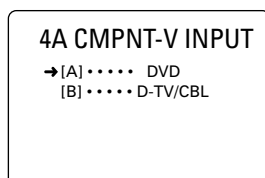

#### ■ 4B OPTICAL OUT (for the OPTICAL OUTPUT jack)

Initial setting: (1) MD/CD-R

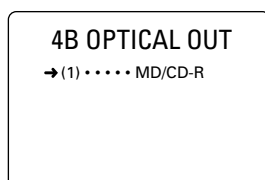

#### ■ 4C OPTICAL IN (for the OPTICAL INPUT jacks)

Initial settings: (2) MD/CD-R

(3) DVD

(4) D-TV/CBL

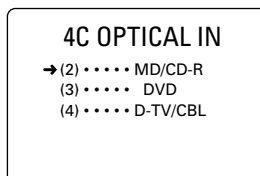

#### ■ 4D COAXIAL IN (for the COAXIAL INPUT jack)

Initial setting: (5) CD

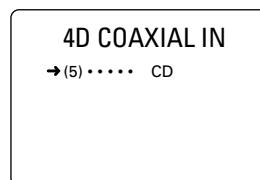

#### Note

- You cannot select an item more than once for the same type of jack.

### 5 INPUT MODE (initial input mode)

Use this feature to designate the input mode when turning on the power with the source component connected to more than one type of the input jacks.

Choices: AUTO, LAST

Initial setting: AUTO

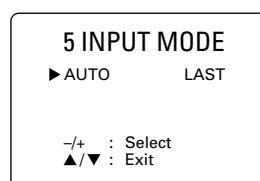

#### AUTO

Select this to allow this unit to automatically detect the type of input signal and select the appropriate input mode.

#### LAST

Select this to set this unit to automatically select the last input mode used for that source.

## 6 DOLBY D. SET (Dolby Digital set)

This setting is effective only when this unit decodes Dolby Digital signals.

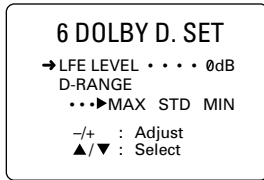

### ■ LFE LEVEL

Use this feature to adjust the output level of the LFE (low-frequency effect) channel when playing back a Dolby Digital signal. The LFE signal carries the low-frequency special effect sound which is only added to certain scenes.

Control value (dB): -20 to 0

Initial setting: 0 dB

#### Notes

- Adjust the LFE level according to the capacity of your subwoofer.
- Normally, around -6 dB to -8 dB is most suitable for listening at home.

### ■ D-RANGE (dynamic range)

Use this feature to adjust the dynamic range (the difference between the maximum level and the minimum level of sounds).

Choices: MAX, STD (standard), MIN

Initial setting: MAX

- Select MAX for feature films.
- Select STD for general use.
- Select MIN for listening to sources at an extremely low volume level.

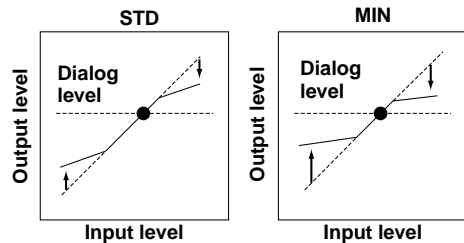
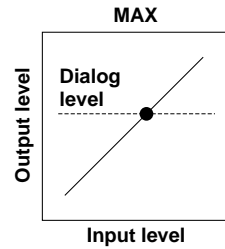

#### Note

- When you select MIN, the sound output may be faint because some Dolby Digital signals are not compatible with the minimum-level dynamic range. In this case, select MAX or STD.

## 7 DTS SET (DTS LFE level)

This setting is effective only when this unit decodes DTS signals.

Use this feature to adjust the output level of the LFE (low-frequency effect) channel when playing back a DTS signal. The LFE signal carries the low-frequency special effect sound which is only added to certain scenes.

Control range (dB): -10 to +10

Initial setting: 0 dB

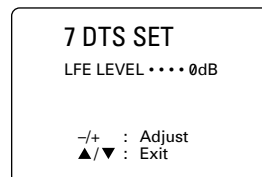

#### Note

- Adjust the LFE level according to the capacity of your subwoofer.

## 8 SP DELAY TIME

Use this feature to adjust the delay of the center channel sound. This feature works when this unit decodes a Dolby Digital or DTS signal. Ideally, the center speaker should be the same distance from the listening position as the left and right main speakers. However, in most home situations, the center speaker is placed in line with the main speakers. By delaying the sound from the center speaker, the apparent distance from the center speaker to the listening position can be adjusted to make it seem the same as the distance between the left and right main speakers to the listening position. Adjusting the delay time for the center speaker is especially important for giving depth to the dialog.

Control range (ms): 0 to 5

Initial setting: 0 ms

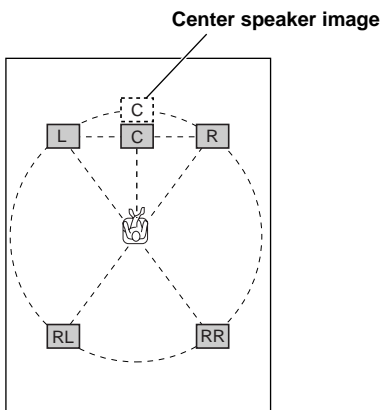
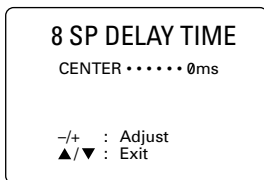

- Increasing the delay by 1 ms simulates moving the speaker about 30 cm (one foot) farther away from the actual position of the center speaker.

## 9 DISPLAY SET

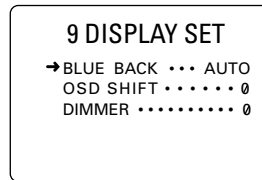

### ■ BLUE BACK

Selecting AUTO for the on-screen display setting displays a blue background when there's no video signal input. Nothing is displayed on the screen including the on-screen display.

Initial setting: AUTO

### ■ OSD SHIFT (OSD off-set position)

This setting is used to adjust the vertical position of the OSD.

Control range: +5 (downward) to -5 (upward)

Initial setting: 0

**Press > to lower the position of the OSD.**

**Press < to raise the position of the OSD.**

### ■ DIMMER

You can adjust the brightness of the front panel display.

Control range: -4 to 0

Initial setting: 0

## 10 MEMORY GUARD

Use this feature to prevent accidental changes to DSP program parameter values and other settings on this unit.

Choices: ON, OFF

Initial setting: OFF



Select ON to protect the following features:

- DSP program parameters
- All SET MENU items
- Center, rear speakers and subwoofer levels
- The on-screen display (OSD) mode

### Notes

- When "10 MEMORY GUARD" is set to ON, you cannot use the test tone.
- When "10 MEMORY GUARD" is set to ON, you cannot select any other SET MENU items.

# ADJUSTING THE LEVEL OF THE EFFECT SPEAKERS

You can adjust the output level of each effect speaker (center, left and right rear and subwoofer) while listening to a music source.

Adjustment should be made with the remote control.

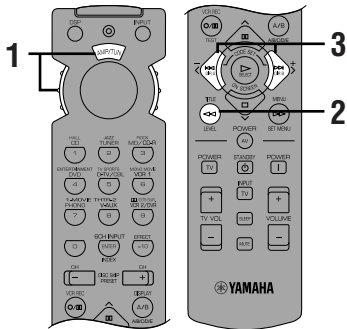

**1** Set the selector dial to the AMP/TUN (or DSP/TUN) position.



**2** Press LEVEL repeatedly to select the speaker(s) you want to adjust.

Each time you press LEVEL, the selected speaker changes and appears on the front panel display and on the video monitor as follows: center, right rear, left rear and subwoofer.

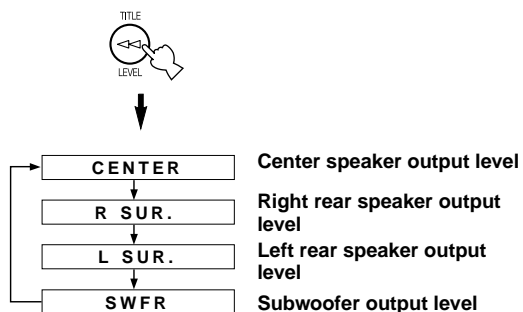

• Once you press LEVEL, you can also select the speaker(s) to be adjusted by pressing  $\nabla$ . (Pressing  $\wedge$  changes the selection in the reverse order.)

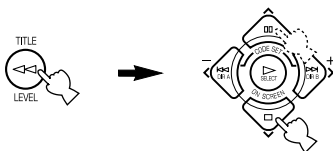

**3** Press  $\langle / \rangle$  to adjust the speaker output level.

- The control range for the center or left and right rear speakers is from +10 dB to -10 dB.
- The control range for the subwoofer is from 0 dB to -20 dB.

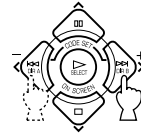

## Notes

- If the speaker output mode is set to NONE, the output level of that speaker cannot be adjusted.
- When you adjust the output level with LEVEL, the settings you made with the test tone will be changed.
- For details on adjusting speakers other than the subwoofer, the adjusting procedure using the test tone on page 21 is recommended.

## Memory back-up

The memory back-up circuit prevents the stored data from being lost even if this unit is set in the standby mode, the power cord is disconnected from the AC outlet, or the power supply is temporarily cut due to power failure. However, if the power is cut for more than one week, the output level of the effect speakers you adjusted will return to the factory settings. If so, adjust the output level again.

# SLEEP TIMER

Use this feature to automatically set this unit in the standby mode after the amount of time you have set. The sleep timer is useful when you are going to sleep while this unit is playing or recording a source. The sleep timer also automatically turns off the external components connected to AC OUTLET(S).

The sleep timer can only be set with the remote control.

## Setting the Sleep Timer

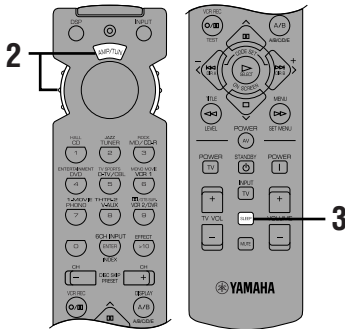

**1** Select a source and start playback on the source component.

**2** Set the selector dial to a position other than the TV position.



**3** Press SLEEP repeatedly to set the amount of time before this unit automatically turns off.



Each time you press SLEEP, the front panel display changes as shown below.

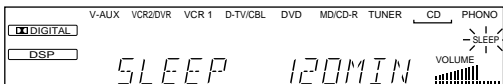
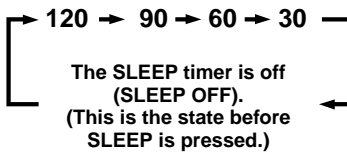

**4** The “SLEEP” indicator soon lights up on the front panel display after the sleep timer has been set.

The display then returns to the previous indication.

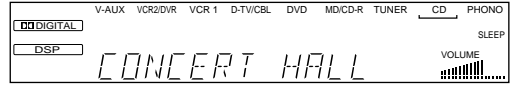

## Canceling the Sleep Timer

Press SLEEP repeatedly until “SLEEP OFF” appears on the front panel display.

After a few seconds, “SLEEP OFF” disappears, the “SLEEP” indicator goes off and the display returns to the previous indication.

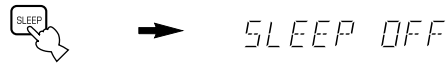

- The sleep timer setting can also be canceled by setting this unit in the standby mode by using STANDBY on the remote control (or STANDBY/ON on the front panel) or by disconnecting the AC power cord from the AC outlet.

# REMOTE CONTROL FEATURES

It is possible to control this unit and other YAMAHA A/V components using the remote control supplied with this unit. It is also possible to control components from other manufacturers (or some YAMAHA components) by setting the proper manufacturer code (a signal assigned to each manufacturer and component).

## Note

- For the notes on batteries, operating distance and names and functions of the remote control, refer each description in this manual.

## Selector Dial

Select the component (position) controlled by the remote control. For example, if the CD position is selected, the remote control is set in the CD operation mode, allowing the CD player to be controlled. When turning the selector dial, the position changes as follows:

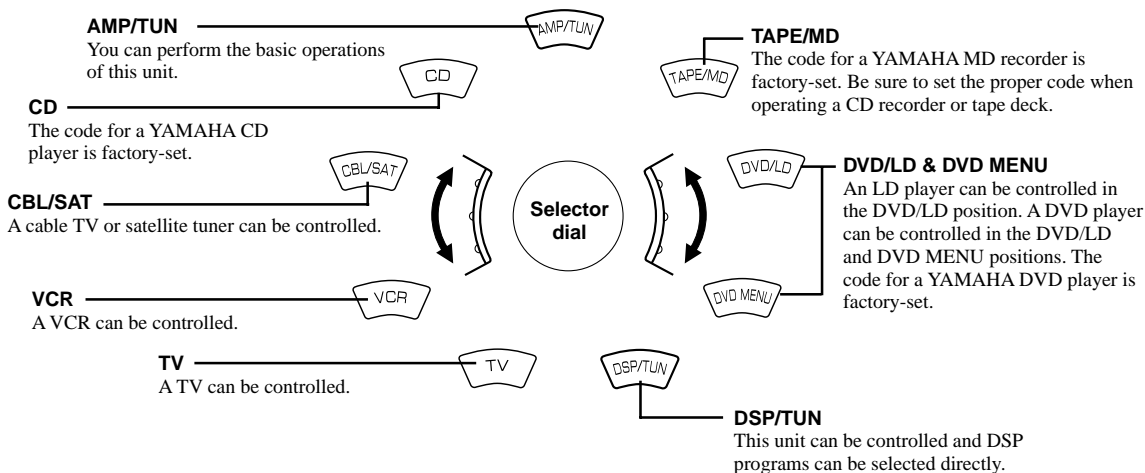

## Notes

- The general operational buttons on the remote control differ depending on the position of the selector dial. See the following pages for details.
- When shipped from the factory, the YAMAHA manufacturer codes listed on page 50 are set for each dial position. If unable to operate your YAMAHA A/V component, please try using another YAMAHA code.



## Commonly Used Buttons in Any Position of the Selector Dial

Regardless of the position of the selector dial, you can control this unit and your TV with the following buttons.

### Note

- You have to set up the code for your TV in the TV position before you can control the TV.

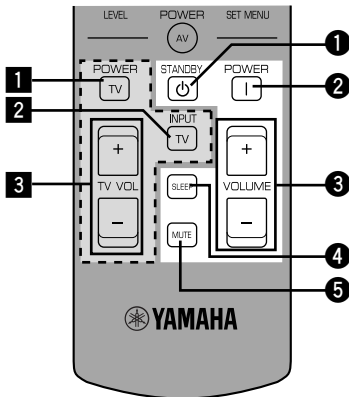

## Controlling this unit

See "Remote Control".

- 1 STANDBY
- 2 POWER
- 3 VOLUME +/-
- 4 SLEEP

### Note

- If you have set up the code for your TV and set the selector dial to the TV position, this button is used to set the sleep timer for the TV.

- 5 MUTE

### Note

- If you have set up the code for your TV and set the selector dial to the TV position, this button is used to mute the TV sound.

## Controlling your TV

- 1 TV POWER
- 2 TV INPUT
- 3 TV VOLUME +/-

## Controlling the Components Connected to This Unit

The example below describes the procedure for controlling a YAMAHA CD player.

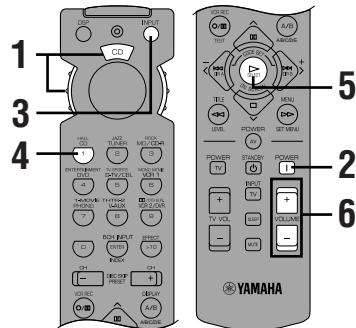

- 1 Set the selector dial to the CD position.



- 2 Turn on the power.



- 3 Press INPUT.

The indicator lights up for about 3 seconds.



- 4 Press CD while the indicator is lit.



- 5 Press .

See "Button Names and Functions in Each Position" for the CD player operation buttons.



- 6 Adjust the volume.



If you set the remote control with the manufacturer codes **listed from page i at the end of this manual**, you can control other brands of components. See "Setting the Manufacturer Codes" for details.

## Button Names and Functions in Each Position

### ■ TAPE/MD position (tape deck, MD recorder or CD recorder)

Select the TAPE/MD position.

**AV POWER**  
This button turns on the tape deck, MD recorder or CD recorder that has a remote control with a power button if you have set up the code for another manufacturer.

**◀◀ DIR A (tape)**  
This button selects the playing direction of deck A.  
**Skip - (MD/CD-R)**

**▶▶ DIR B (tape)**  
This button selects the playing direction of deck B.  
**Skip + (MD/CD-R)**

**◻ Stop**

**▶▶ Fast forward (tape)**  
**Search (MD/CD-R)**

**◻ Pause (MD/CD-R)**

**▶ Play**

**◻ Rec/Pause (tape/MD)**

**Numeric buttons (MD/CD-R)**

**INDEX (CD-R)**

**+10 (MD/CD-R)**

**Deck A/B (tape)**  
This button selects deck A or B on a double-cassette tape deck.

**DISPLAY (MD/CD-R)**

### ■ CD position

Select the CD position.

**DISC SKIP -/+ (for a CD player with CD changer)**

**▶ Play**

**◀◀ Skip -**

**◀◀ Search**

**◻ Pause**  
YAMAHA CD player (factory settings): Pause/Stop

**▶▶ Skip +**

**◻ Stop**  
YAMAHA CD player (factory settings): Pause/Stop

**▶▶ Search**

**AV POWER**  
This button turns on the CD player that has a remote control with a power button if you have set up the code for another manufacturer.

**Numeric buttons**

**INDEX**

**+10**

**DISPLAY**

**☀ - Pause/Stop function**  
• Press the button once to give a pause in operation and press once more to stop operation.

- The dark-shaded buttons do not function even if you have set up the manufacturer code.
- Some of them may not function depending on the component you have. In this case, use the original remote control supplied with your component.

## DVD/LD position

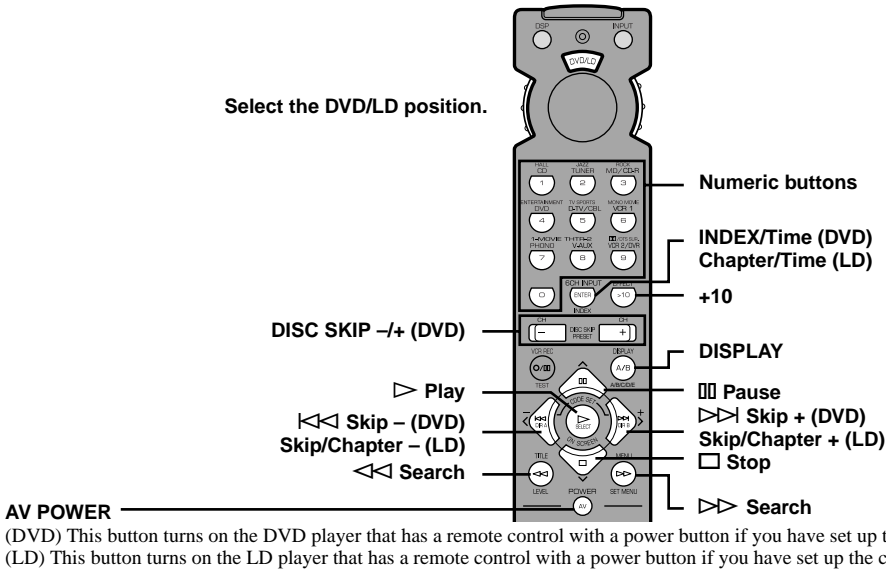

(DVD) This button turns on the DVD player that has a remote control with a power button if you have set up the code for another manufacturer.  
 (LD) This button turns on the LD player that has a remote control with a power button if you have set up the code for another manufacturer.

## DVD MENU position

### Note

- DVD MENU operations cannot be performed for some DVD players.

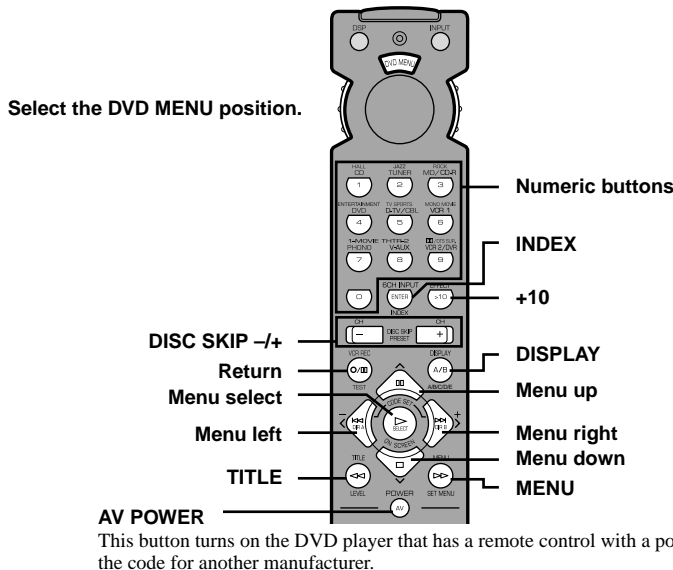

This button turns on the DVD player that has a remote control with a power button if you have set up the code for another manufacturer.

- The dark-shaded buttons do not function even if you have set up the manufacturer code.
- Some of them may not function depending on the component you have. In this case, use the original remote control supplied with your component.

## VCR position

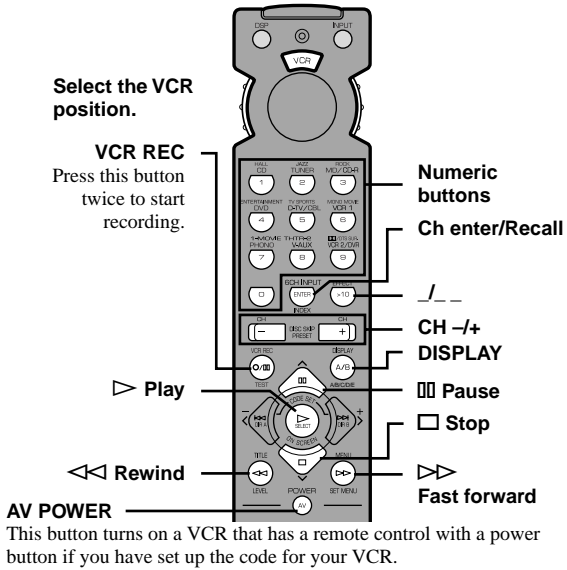

## CBL/SAT position

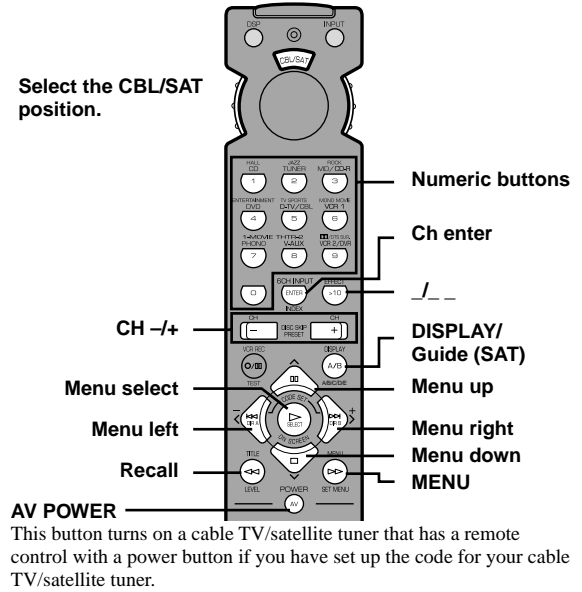

## TV position

### Note

- You can control your VCR if you have set up the code for it in the VCR position.

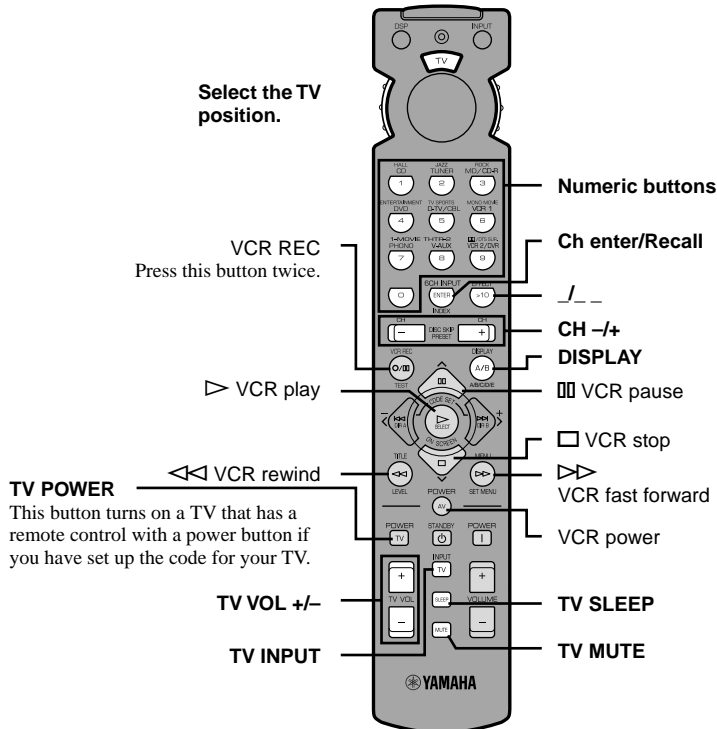

- The dark-shaded buttons do not function even if you have set up the manufacturer code.
- Some of them may not function depending on the component you have. In this case, use the original remote control supplied with your component.

## Setting the Manufacturer Code

You can set up the code for the manufacturer of your component in each position of the selector dial.

**1** Turn on your component to be used.

**2** Set the selector dial to the desired position for the component (TAPE/MD, CD, DVD/LD, etc.).

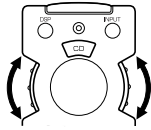

**3** Press </> at the same time for about 4 seconds.

The indicator flashes twice.

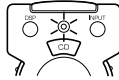
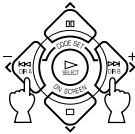

**4** Use the numeric buttons to enter the four-digit manufacturer code for the component to be used. Make sure that the indicator flashes twice.

If the indicator does not flash or flashes rapidly several times, repeat step 3 and re-enter the code.

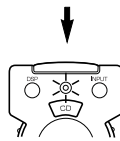
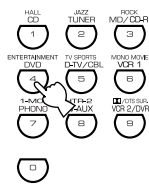

**5** Press AV POWER (or any other button) to check if you have set up the code correctly.

If your component cannot be controlled with the remote control, try setting another code for the same manufacturer.



### Notes

- You can set up only one code for one position.
- In the DVD/LD and DVD MENU positions: Be sure to set the selector dial to the DVD/LD position before entering the code for the DVD/LD player. You cannot set up the code for a DVD player when the selector dial is set to the DVD MENU position. The code set up in the DVD/LD position is also simultaneously set up in the DVD MENU position.
- If your component does not respond to any of the codes listed for the manufacturer, use the original remote control supplied with your component.

## To use a second (and third) VCR

You can control a second (and third) VCR in the CBL/SAT and DVD MENU positions if a cable TV/satellite tuner or DVD player is not being used.

### Note

- In order to set a second (and third) VCR in the DVD MENU position, it is necessary to first set up the code for an LD player in the DVD/LD position.

**1** Turn on the VCR to be used.

**2** Set the selector dial to the CBL/SAT or DVD MENU position.

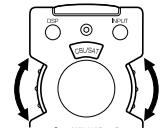

**3** Press </> at the same time for about 4 seconds.

The indicator flashes twice.

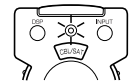
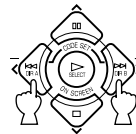

**4** Use the numeric buttons to enter the four-digit code for the second (and third) VCR. Make sure that the indicator flashes twice.

If the indicator does not flash or flashes rapidly several times, repeat step 3 and re-enter the code.

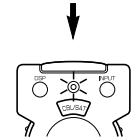
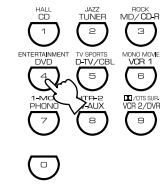

**5** Press AV POWER (or any other button) to check if you have set up the code correctly.

If the VCR cannot be controlled with the remote control, try setting another code for the same manufacturer.



## Returning to the Factory Setting

### To return to the factory-set codes in all positions

**1** Press **</>** at the same time for about 4 seconds.

The indicator flashes twice.



**2** Enter the code number "9990".

Make sure that the indicator flashes twice.

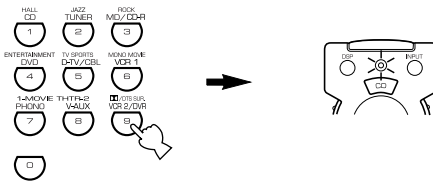

The following codes are factory set.

Selector dial position	Component	Code	Set component	Set code
TV	TV	0101		
CBL/SAT	Cable TV	0006		
VCR	VCR	0002		
DVD/LD	DVD player	0008 (YAMAHA DVD player)		
CD	CD player	0005 (YAMAHA CD player)		
TAPE/MD	MD recorder	0024 (YAMAHA MD recorder)		

We recommend that you write all the code numbers you have set on the table above.

### To return to the factory-set codes in each position

**1** Set the selector dial to the position for the component to be returned to the factory setting.

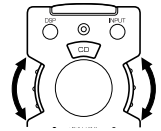

**2** Press **</>** at the same time for about 4 seconds.

The indicator flashes twice.

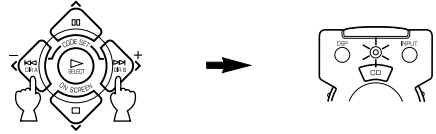

**3** Enter the code number "0000".

Make sure that the indicator flashes twice.

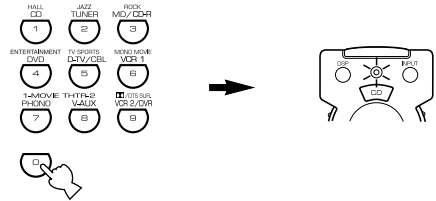

# SOUND FIELD PROGRAM

A digital sound field processor (DSP) based on the latest YAMAHA technology is built into this unit. It is possible to play back various sound fields for the source you are listening to.

## Note

- Regardless of the program name and features listed in the table below, select the sound field program that sounds best to you.

## Hi-Fi DSP Programs

### ■ For audio sources: Nos. 1 to 4

No.	Program (group)	Sub-program	Features
1	CONCERT HALL	—	A large round concert hall with a rich surround effect. Pronounced reflections from all directions emphasize the extension of sounds. The sound field has a great deal of presence, and your virtual seat is near the center, close to the stage.
2	JAZZ CLUB	—	This is the sound field at stage front in “The Bottom Line”, a famous New York jazz club. The floor can seat 300 people to the left and right in a sound field offering a real and vibrant sound.
3	ROCK CONCERT	—	The ideal program for lively, dynamic rock music. The data for this program was recorded at LA’s “hottest” rock club. The listener’s virtual seat is at the center-left of the hall.
4	ENTERTAINMENT	DISCO	This program recreates the acoustic environment of a lively disco in the heart of a big city. The sound is dense and highly concentrated. It is also characterized by a high-energy, “immediate” sound.
		5CH STEREO	Using this program increases the listening position range. This is a sound field suitable for background music at parties.

## Note

- Reverberations (sound effects) for realizing the sound field and unprocessed stereo from the left and right main speakers is output. The sound is not output from the center speaker. (The sound is output when one of these programs is selected while playing a source encoded with a Dolby Digital or DTS signal. If 5CH STEREO is selected, the sound is output from all speakers regardless of the input source.)

## CINEMA DSP Programs

### ■ For audio-video sources: Nos. 4 to 6

No.	Program (group)	Sub-program	Features
4	ENTERTAINMENT	GAME	This program adds a deep and spatial feeling to video game sounds.
5	TV SPORTS	—	Although the presence sound field is relatively narrow, the surround sound field employs the sound environment of a large concert hall. With this program, you can enjoy watching various TV programs such as news, variety shows, music programs or sports programs. In a stereo broadcast of a sports game, the commentator is oriented at the center position, and the shouts and the atmosphere in the stadium spread on the surround side, while their spread to the rear is properly restrained.
6	MONO MOVIE	—	This program is provided for reproducing monaural video sources (such as old movies). The program produces the optimum reverberation to create sound depth by using only the presence sound field.

## ■ For movie programs: Nos. 7 to 9

No.	Program (group)	Sub-program		Input source	Features	
7	MOVIE THEATER 1	SPECTACLE	70 mm SPECTACLE	Analog, PCM, Dolby Digital in 2-channel	This program creates the extremely wide sound field of a 70-mm movie theater. It precisely reproduces the source sound in detail, making both the video and the sound field incredibly real. This is ideal for any kind of video source encoded with Dolby Surround, Dolby Digital or DTS (especially large-scale movie productions).	
			DGTL SPECTACLE	Dolby Digital (5.1-channel)		
			DTS SPECTACLE	DTS		
		SCI-FI	70 mm SCI-FI	Analog, PCM, Dolby Digital in 2-channel		This program clearly reproduces dialog and sound effects in the latest sound form of science fiction films, thus creating a broad and expansive cinematic space amid the silence. You can enjoy science fiction films in a virtual-space sound field that includes Dolby Surround, Dolby Digital and DTS-encoded software employing the most advanced techniques.
			DGTL SCI-FI	Dolby Digital (5.1-channel)		
			DTS SCI-FI	DTS		
8	MOVIE THEATER 2	ADVENTURE	70 mm ADVENTURE	Analog, PCM, Dolby Digital in 2-channel	This program is ideal for precisely reproducing the sound design of the newest 70-mm and multichannel soundtrack films. The sound field is made to be similar to that of the newest movie theaters, so the reverberations of the sound field itself are restrained as much as possible.	
			DGTL ADVENTURE	Dolby Digital (5.1-channel)		
			DTS ADVENTURE	DTS		
		GENERAL	70 mm GENERAL	Analog, PCM, Dolby Digital in 2-channel		This program is for reproducing sounds from 70-mm and multichannel soundtrack films, and is characterized by a soft and extensive sound field. The presence sound field is relatively narrow. It spatially spreads all around and toward the screen, restraining the echo effect of conversations without losing clarity. For the surround sound field, the harmony of music or chorus sounds beautifully in a wide space at the rear of the sound field.
			DGTL GENERAL	Dolby Digital (5.1-channel)		
			DTS GENERAL	DTS		
9	Dolby Digital/DTS SURROUND	NORMAL	PRO LOGIC/NORMAL	Analog, PCM, Dolby Digital in 2-channel	The built-in decoder precisely reproduces sounds and sound effects from sources. The highly efficient decoding process improves crosstalk and channel separation, and makes sound positioning smoother and more precise. In this program, the digital sound field processor is not turned on.	
			DOLBY DIGITAL/NORMAL	Dolby Digital (5.1-channel)		
			DTS DIGITAL SUR./NORMAL	DTS		
		ENHANCED	PRO LOGIC/ENHANCED	Analog, PCM, Dolby Digital in 2-channel		This program ideally simulates the multi-surround speaker systems of the 35-mm film theaters. Dolby Pro Logic decoding, Dolby Digital decoding or DTS decoding and digital sound field processing create precise effects without altering the original sound orientation. The surround effects produced by this sound field wrap around the viewer naturally from the back to the left and right, and toward the screen.
			DOLBY DIGITAL/ENHANCED	Dolby Digital (5.1-channel)		
			DTS DIGITAL SUR./ENHANCED	DTS		

### Notes

- The “ DSP” indicator does not light up when selecting the sub-program “NORMAL” of the Dolby Digital/DTS SURROUND program.
- If “1A CENTER SP” on the SET MENU is set to NONE, no sound is output from the center speaker.
- The effect sound is output from the main speakers when a monaural source is played with CINEMA DSP program groups 4 (GAME) and 5 to 8.



## ■ MOVIE THEATER 1 and 2

Most commercially available movie software has 4-channel (left, center, right and surround) sound information encoded by Dolby Surround matrix processing and stored on the left and right tracks. These signals are processed by the Dolby Pro Logic decoder. The MOVIE THEATER programs are designed to recreate the spaciousness and delicate nuances of sound that tend to be lost in the encoding and decoding processes.

The 6-channel soundtracks found on 70-mm film produce precise sound field localization and rich, deep sound without using matrix processing. This unit's MOVIE THEATER 70 mm programs provide the same quality of sound and sound localization that 6-channel soundtracks do.

### When the input source is analog, PCM or encoded with Dolby Digital in 2-channel

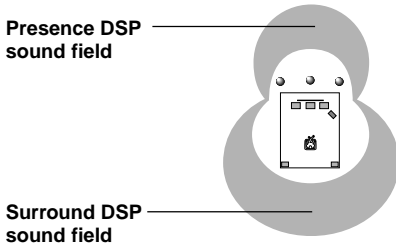

These programs express an immense sound field and a large surround effect. They also give depth to the sound from the main speakers to recreate the realistic sound of a Dolby Stereo theater.

**70 mm SPECTACLE**  
**70 mm SCI-FI**  
**70 mm ADVENTURE**  
**70 mm GENERAL**

The built-in Dolby Digital or DTS decoder brings the professional-quality sound designed for movie theaters into your home. With the unit's MOVIE THEATER programs, you can recreate a dynamic sound that gives you the feeling of being at a public theater in your listening room by using Dolby Digital or DTS technology.

### When the input source is encoded with Dolby Digital (5.1-channel) or DTS (Tri-Field CINEMA DSP)

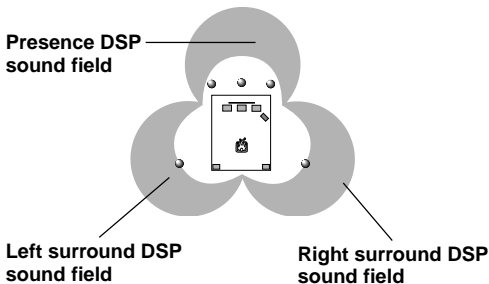

These programs use YAMAHA's tri-field DSP processing on each of the Dolby Digital or DTS signals for the front, left surround and right surround channels. This processing enables this unit to reproduce the immense sound field and surround expression of a Dolby Digital- or DTS-equipped movie theater without sacrificing the clear separation of all channels.

**DGTL SPECTACLE**  
**DTS SPECTACLE**  
**DGTL SCI-FI**  
**DTS SCI-FI**  
**DGTL ADVENTURE**  
**DTS ADVENTURE**  
**DGTL GENERAL**  
**DTS GENERAL**



- If a Dolby Digital signal or DTS signal is input when the input mode is set to AUTO, the DSP program will be automatically switched to the Dolby Digital playback sound field or DTS playback sound field.

# SOUND FIELD PROGRAM PARAMETER EDITING

## *What is a sound field?*

What really creates the rich, full tones of a live instrument are the multiple reflections from the walls of the room. In addition to making the sound “live”, these reflections enable us to tell where the player is situated, and the size and shape of the room in which we are sitting.

### ■ Elements of a sound field

In any environment, in addition to the direct sound coming straight to our ears from the player’s instrument, there are two distinct types of sound reflections that combine to make up the sound field:

#### **Early reflections**

Reflected sounds reach our ears extremely rapidly (50 ms – 100 ms after the direct sound), after reflecting from one surface only — for example, from the ceiling or a wall. These reflections fall into specific patterns for any particular environment, and provide vital information to our ears. Early reflections actually add clarity to the direct sound.

#### **Reverberations**

These are caused by reflections from more than one surface — walls, ceiling, the back of the room — so numerous that they merge together to form a continuous sonic “afterglow”. They are non-directional, and lessen the clarity of the direct sound.

Direct sound, early reflections and subsequent reverberation taken together help us to determine the subjective size and shape of the room, and it is this information that the digital sound field processor reproduces in order to create sound fields.

If you could create the appropriate early reflections and subsequent reverberations in your listening room, you would be able to create your own listening environment. The acoustics in your room could be changed to those of a concert hall, a dance floor, or virtually any size room at all. This ability to create sound fields at will is exactly what YAMAHA has done with the digital sound field processor.

## *Sound Field Program Parameters*

DSP programs consist of some parameters to determine the apparent room size, reverberation time, distance from you to the performer, etc. In each program, these parameters are set with values precisely calculated by YAMAHA to create a sound field unique to the program. It is recommended to use DSP programs without changing the values of parameters; however, this unit also allows you to create your own sound fields. Starting with one of the built-in programs, you can adjust those parameters.

Each DSP program has a set of parameters that allow you to change the characteristics of the acoustic environment to precisely create the effect you want. These parameters correspond to the many natural acoustic factors that create the sound field you experience in an actual concert hall or other listening environment. The size of the room, for example, affects the length of time between the early reflections. The “ROOM SIZE” parameter provided in many of the DSP programs alters the timing between these reflections, thus changing the shape of the “room” you are listening. In addition to room size, the shape of the room and the characteristics of its surfaces have a significant effect on the final sound. Surfaces that absorb sound, for example, cause the reflections and reverberations to die out more quickly, while highly reflective surfaces allow the reflections to carry on for a longer period of time. The digital sound field parameters allow you to control these and many other factors that contribute to your personal sound field, allowing you to essentially “redesign” the concert halls, theaters, etc. provided to create custom-tailored listening environments that ideally match your mood and music.

See “Sound Field Parameter Descriptions”.

## Changing Parameter Settings

Although it is possible to enjoy playback on your system without changing default setting parameters for the sound field program, it is also possible to enjoy specifically tailor the sound field program to the characteristics of the source and the acoustics of the listening room.

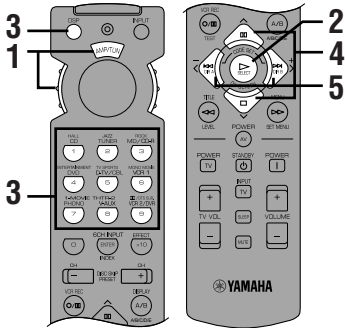

**1** Set the selector dial to the DSP/TUN (or AMP/TUN) position.

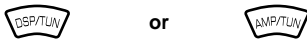

**2** Turn on the video monitor and press ON SCREEN repeatedly to select the full display mode.

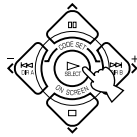

**3** Select a DSP program you want to adjust.

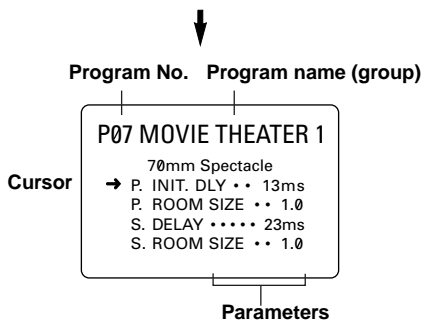
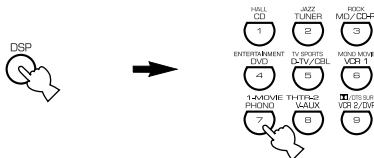

Example of the MOVIE THEATER 1

**4** Press  $\swarrow/\searrow$  to select the parameter.

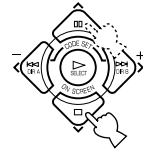

**5** Press  $\langle / \rangle$  to change the parameter value.

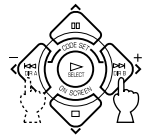

- When you set the parameter to a value other than the factory-set value, an asterisk mark (\*) appears by the parameter name on the video monitor.

**6** Repeat steps 3 to 5 above as necessary to change other program parameters.

### Memory back-up

The memory back-up circuit prevents the stored data from being lost even if this unit is set in the standby mode, the power cord is disconnected from the AC outlet, or the power supply is temporarily cut due to power failure. However, if the power is cut for more than one week, the parameter value you edited will return to the factory setting. If so, edit the parameter value again.

### Resetting a Parameter to the Factory-set Value

Select the parameter you want to reset. Then press and hold  $\langle$  or  $\rangle$  until the value temporarily stops at the factory-set value. The asterisk mark (\*) by the parameter name disappears on the video monitor.

#### Notes

- The available parameters may be displayed on more than one OSD page for some of the programs. To scroll through pages, press  $\swarrow/\searrow$ .
- You cannot change parameter values when "10 MEMORY GUARD" on the SET MENU is set to ON. If you want to change the parameter values, set "10 MEMORY GUARD" to OFF.

## Sound Field Parameter Descriptions

You can adjust the values of certain sound field parameters so the sound fields are recreated accurately in your listening room.

**Note**

- Not all of the following parameters can be found in every program.

### ■ INIT.DLY (initial delay) (P.INIT.DLY — for the presence sound field)

**Function:** This parameter changes the apparent distance from the sound source by adjusting the delay between the direct sound and the first reflection heard by the listener.

**Control range:** 1 – 99 msec

**Description:** The smaller the value, the closer the sound source seems to the listener. The larger the value, the farther the apparent distance seems. For a small room, this parameter would be set to a small value, for a large room, set it to a large value.

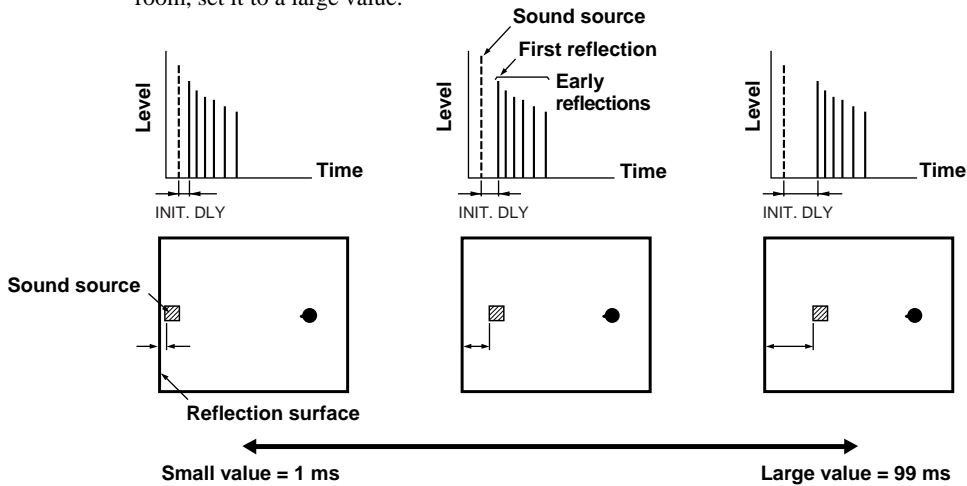

### ■ ROOM SIZE (P.ROOM SIZE — for the presence sound field)

**Function:** This parameter adjusts the apparent size of the surround sound field. The larger the value, the larger the surround sound field becomes.

**Control range:** 0.1 – 2.0

**Description:** As the sound is repeatedly reflected around a room, the larger the hall is, the longer the time between the original reflected sound and the subsequent reflections. By controlling the time between the reflected sounds, you can change the apparent size of the virtual venue. Changing this parameter from one to two, doubles the apparent length of the room.

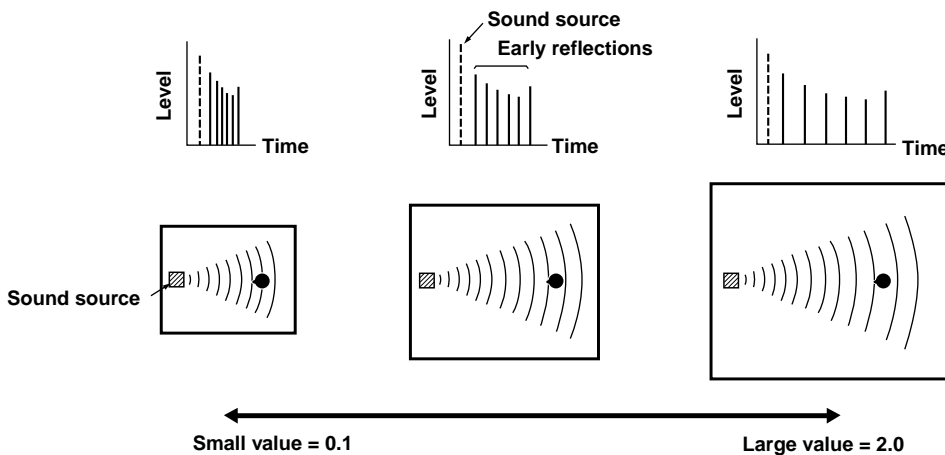

## ■ LIVENESS

**Function:** This parameter adjusts the reflectivity of the virtual walls in the hall by changing the rate at which the early reflections decay.

**Control range:** 0 – 10

**Description:** The early reflections of a sound source decay much faster in a room with acoustically absorbent wall surfaces than in one which has highly reflective surfaces. A room with acoustically absorbent surfaces is referred to as “dead,” while a room with highly reflective surfaces is referred to as “live”. The “LIVENESS” parameter lets you adjust the early reflection decay rate, and thus the “liveness” of the room.

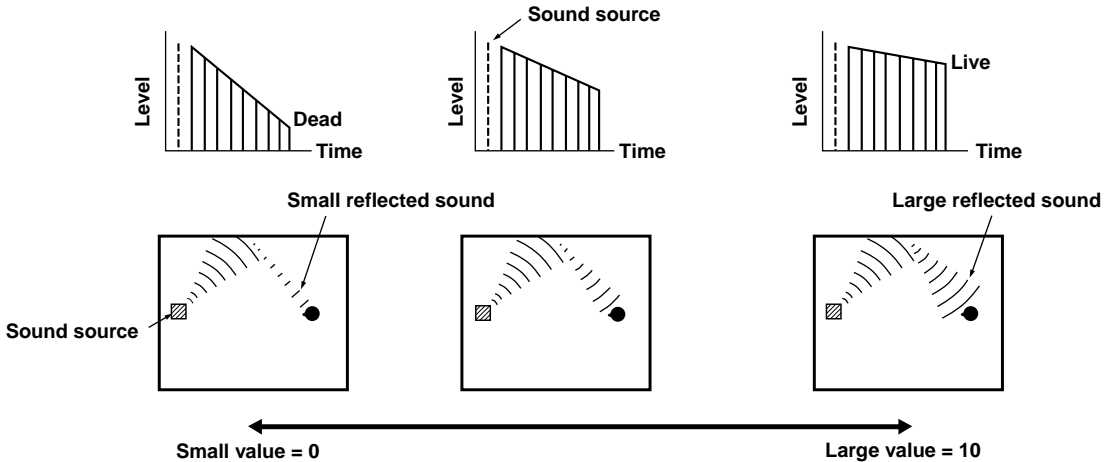

## ■ S.DELAY (surround delay)

**Function:** This parameter adjusts the delay between the direct sound and the first reflection in the surround sound field.

**Control range:** 0 – 49 msec (The range depends on the signal format.)

## ■ S.INIT.DLY (surround initial delay)

**Function:** This parameter adjusts the delay between the direct sound and the first reflection on the surround side of the sound field. You can only adjust this parameter when at least two front channels and two rear channels are used.

**Control range:** 1 – 49 msec

■ **S.ROOM SIZE (surround room size)**

Function: This parameter adjusts the apparent size of the surround sound field.

Control range: 0.1 – 2.0

■ **S.LIVENESS (surround liveness)**

Function: This parameter adjusts the apparent reflectivity of the virtual walls in the surround sound field.

Control range: 0 – 10

■ **CT.DELAY (center delay)**

Function: These parameters adjust the sound delay for each channel in 5 channel stereo mode.

Control range: 0 – 50 msec

■ **LS.DELAY (left surround delay)**

Function: These parameters adjust the sound delay for each channel in 5 channel stereo mode.

Control range: 0 – 50 msec

■ **RS.DELAY (right surround delay)**

Function: These parameters adjust the sound delay for each channel in 5 channel stereo mode.

Control range: 0 – 50 msec

# TROUBLESHOOTING

Refer to the chart below when the unit does not function properly. If the problem you are experiencing is not listed below or if the instruction below does not help, set this unit in the standby mode, disconnect the power cord and contact the nearest authorized YAMAHA dealer or service center.

## ■ General

Problem	Cause	Remedy	Refer to page
<b>The unit fails to turn on when STANDBY/ON (or POWER) is pressed, or enters in the standby mode soon after the power has been turned on.</b>	The power cord is not connected or the plug is not completely inserted.	Firmly connect the power cord.	18
	The IMPEDANCE SELECTOR switch on the rear panel is not fully set to the left or right position.	Set the switch fully to the left or right position when the unit is in the standby mode.	18
	The protection circuitry has been activated.	Make sure all speaker wire connections on this unit and on all speakers are secure and that the wire for each connection does not touch anything other than its respective connection.	16, 17
<b>On-screen display does not appear.</b>	The setting for the on-screen display is set to "DISPLAY OFF".	Select the full display or short display mode.	20
	The BLUE BACK setting under "9 DISPLAY SET" on the SET MENU is set to OFF, and no video signal is input to this unit.	Set BLUE BACK to AUTO to always show the OSD.	41
<b>No sound and/or no picture.</b>	Incorrect input or output cable connections.	Connect the cables properly. If the problem persists, the cables may be defective.	12 – 15
	An appropriate input source has not been selected.	Select an appropriate input source with INPUT ◀/▶ or 6CH INPUT (or the input selector buttons).	23
	The speaker connections are not secure.	Secure the connections.	16, 17
	The main speakers to be used have not been selected properly.	Select the main speakers with SPEAKERS A and/or B.	23
	The volume is turned down.	Turn up the volume.	24
	The sound is muted.	Press MUTE or any operation buttons to cancel a mute and adjust the volume.	24
	Digital signals other than PCM audio, Dolby Digital or DTS signal which this unit cannot reproduce are being input to this unit by playing a CD-ROM, etc.	Play a source whose signals this unit can reproduce.	—
<b>The picture does not appear.</b>	The output and input for the picture are connected to different types of video jacks.	Make connections using the same type of jack (between composites, S-VIDEOS, or components) for both the input and output.	14, 15
<b>The sound suddenly goes off.</b>	The protection circuit has been activated because of a short circuit, etc.	Check the IMPEDANCE SELECTOR switch is set to the appropriate position and then turn the unit back on.	18
		Check the speaker wires are not touching each other and then turn the unit back on.	16, 17
	The sleep timer has functioned.	Turn on the power, and play the source again.	43
	The sound is muted.	Press MUTE or any operation buttons to cancel a mute and adjust the volume.	24
<b>Only the speaker on one side can be heard.</b>	Incorrect cable connections.	Connect the cables properly. If the problem persists, the cables may be defective.	12 – 17

<b>Problem</b>	<b>Cause</b>	<b>Remedy</b>	<b>Refer to page</b>
<b>No sound from the effect speakers.</b>	The sound effect is off.	Press EFFECT to turn it on.	28
	A Dolby Surround, Dolby Digital or DTS decoding DSP program is being used with material not encoded with Dolby Surround, Dolby Digital or DTS.	Select another DSP program.	51, 52
	A 96-kHz sampling digital signal is being input to this unit.		24
<b>No sound from the center speaker.</b>	The output level of the center speaker is set to minimum.	Raise the level of the center speaker.	42
	“1A CENTER SP” on the SET MENU is set to NONE.	Select the appropriate mode for your center speaker.	36
	One of the Hi-Fi DSP programs (1 to 4) has been selected.	Select another DSP program.	51, 52
	The source encoded with a Dolby Digital or DTS signal does not have a center channel signal.		—
<b>No sound from the rear speakers.</b>	The output level of the rear speakers is set to minimum.	Raise the output level of the rear speakers.	42
	A monaural source is being played with the program 9.	Select another DSP program.	51, 52
<b>No sound from the subwoofer.</b>	“1D LFE/BASS OUT” on the SET MENU is set to MAIN when a Dolby Digital or DTS signal is being played.	Select SWFR or BOTH.	38
	“1D LFE/BASS OUT” on the SET MENU is set to SWFR or MAIN when a 2-channel source is being played.	Select BOTH.	38
	The source does not contain low bass signals (90 Hz and below).		—
<b>Poor bass reproduction.</b>	“1D LFE/BASS OUT” on the SET MENU is set to SWFR or BOTH and your system does not include a subwoofer.	Select MAIN.	38
	The output mode for each speaker (main, center or rear) on the SET MENU does not match your speaker configuration.	Select the appropriate output mode for each speaker based on the size of the speakers in your configuration.	36, 37
<b>A “humming” sound can be heard.</b>	Incorrect cable connections.	Firmly connect the audio plugs. If the problem persists, the cables may be defective.	12 – 15
	No connection from the turntable to the GND terminal.	Connect the grounding cord of your turntable to the GND terminal of this unit.	12, 13
<b>The volume level is low while playing a record.</b>	The record is being played on a turntable with an MC cartridge.	The turntable should be connected to the unit through an MC-head amplifier.	12



Problem	Cause	Remedy	Refer to page
<b>The volume level cannot be increased, or the sound is distorted.</b>	The component connected to the REC OUT jacks of this unit is turned off.	Turn on the power to the component.	12
<b>The effect and surround sounds cannot be recorded.</b>	It is not possible to record the effect and surround sounds by a recording component.		34
<b>A source cannot be recorded by a digital recording component connected to the DIGITAL OUTPUT jack of this unit.</b>	A source component is only connected to the analog input jacks of this unit.	Connect the source component to the digital input jacks of this unit.	12 – 15
<b>The sound field parameters and some other settings on this unit cannot be changed.</b>	“10 MEMORY GUARD” on the SET MENU is set to ON.	Select OFF.	41
<b>When TUNER is selected, the DSP program name shown on the display immediately changes to the frequency.</b>	The OSD mode is set to short display or display off.	If you want the DSP program name display to be shown constantly, set the OSD mode to full display.	19
<b>This unit does not operate properly.</b>	The internal microcomputer has been frozen by an external electric shock (such as lightning or excessive static electricity) or by a power supply with low voltage.	Disconnect the AC power cord from the outlet and then plug it in again after about 30 seconds.	—
<b>The sound is degraded when listening with headphones connected to a tape deck or CD player that is connected to this unit.</b>	This unit is in the standby mode.	Turn on the power of the unit.	—
<b>There is noise interference from digital or high-frequency equipment, or the unit.</b>	The unit is too close to the digital or high-frequency equipment.	Move the unit further away from such equipment.	—

## ■ Tuner

	Problem	Cause	Remedy	Refer to page
FM	<b>FM stereo reception is noisy.</b>	The characteristics of FM stereo broadcasts may cause this problem when the transmitter is too far away or the antenna input is poor.	Check the antenna connections. Try using a high-quality directional FM antenna. Use the manual tuning method.	29, 30
	<b>There is distortion, and clear reception cannot be obtained even with a good FM antenna.</b>	There is multipath interference.	Adjust the antenna position to eliminate multipath interference.	29
	<b>The desired station cannot be tuned in with the automatic tuning method.</b>	The station is too weak.	Use the manual tuning method. Use a high-quality directional FM antenna.	29, 30
	<b>Previously preset stations can no longer be tuned in.</b>	The unit has been disconnected for a long period.	Re-store the stations.	31
AM	<b>The desired station cannot be tuned in with the automatic tuning method.</b>	The signal is weak or the antenna connections are loose.	Tighten the AM loop antenna connections and orient it for best reception. Use the manual tuning method.	29, 30
	<b>There are continuous crackling and hissing noises.</b>	Noises result from lightning, fluorescent lamps, motors, thermostats and other electrical equipment.	Use an outdoor antenna and a ground wire. This will help somewhat, but it is difficult to eliminate all noise.	29
	<b>There are buzzing and whining noises (especially in the evening).</b>	A TV set is being used nearby.	Move this unit away from the TV.	—

## ■ Remote control

Problem	Cause	Remedy	Refer to page
<b>The remote control does not work nor function properly.</b>	Wrong distance or angle.	The remote control will function within a maximum range of 6 m (20 feet) and no more than 30 degrees off-axis from the front panel.	8
	Direct sunlight or lighting (from an inverter type of fluorescent lamp, etc.) is striking the remote control sensor of this unit.	Reposition the unit.	—
	The batteries are weak.	Replace all batteries with new ones.	3
<b>The unit or other component cannot be controlled.</b>	The component to be controlled has not been selected.	Set the selector dial to the appropriate position, corresponding to the component to be controlled.	44
	The remote control cannot control system components.		—
	The manufacturer code has not been set up properly.	Enter the code again.	49
		Try setting another code for the same manufacturer.	
Depending on the manufacturer or the model, some components cannot be controlled with this unit's remote control even though the code has been set up properly.	Use the original remote control supplied with your component.	—	

After this unit has been exposed to a strong external electric shock (such as lightning and strong static electricity) or if you mishandle the operation of this unit, it may not function properly. In these cases, set this unit in the standby mode, disconnect the power cord, plug it back in after 30 seconds, and start operating.

# SPECIFICATIONS

## AUDIO SECTION

- Minimum RMS Output Power for Main, Center, Rear  
20 Hz to 20 kHz, 0.06% THD, 8 ohms  
[U.S.A. and Canada models] ..... 100 W  
[Australia, Singapore, China and General models] ..... 90 W
- 1 kHz, 0.09% THD, 8 ohms  
[U.S.A. and Canada models] ..... 110 W  
1 kHz, 0.06% THD, 8 ohms  
[Australia, Singapore, China and General models] ..... 100 W
- Maximum Power (EIAJ)  
[China and General models]  
1 kHz, 10% THD, 8 ohms ..... 115 W
- Dynamic Power (IHF)  
8/6/4/2 ohms  
[U.S.A. and Canada models] ..... 130/150/190/240 W  
[Australia, Singapore, China and General models]  
..... 120/140/175/210 W
- Damping Factor  
20 Hz to 20 kHz, 8 ohms ..... 80 or more
- Frequency Response  
CD to Main L/R ..... 10 Hz to 100 kHz, -3 dB
- RIAA Equalization Deviation  
PHONO (MM) ..... ±0.5 dB
- Total Harmonic Distortion  
PHONO MM (20 Hz to 20 kHz, 1 V, REC OUT) .... 0.02% or less  
CD, etc. (20 Hz to 20 kHz, 45 W, 8 ohms, Main L/R)  
..... 0.06% or less
- Signal to Noise Ratio (IHF-A Network)  
PHONO MM to REC OUT (5 mV, shorted)  
[U.S.A., Canada, China and General models] ..... 86 dB or more  
[Australia and Singapore models] ..... 81 dB or more  
CD (250 mV, shorted) to Main L/R, Effect Off .... 100 dB or more
- Residual Noise (IHF-A Network)  
Main L/R ..... 150 µV or less
- Channel Separation (1 kHz/10 kHz)  
CD (5.1 kohms terminated) to Main L/R ..... 60 dB/45 dB
- Tone Control (Main L/R)  
BASS Boost/Cut ..... ±10 dB/50 Hz  
TREBLE Boost/Cut ..... ±10 dB/20 kHz  
BASS EXTENSION ..... +6 dB/60 Hz
- Phones Output ..... 400 mV/560 ohms
- Input Sensitivity  
CD, etc ..... 150 mV/47 kohms  
PHONO ..... 2.5 mV/47 kohms  
6CH INPUT ..... 150 mV/47 kohms
- Maximum Input Signal  
PHONO MM (1 kHz, 0.1% THD) ..... 100 mV or more  
CD, etc. (1 kHz, 0.5% THD) ..... 2.2 V or more
- Output Level  
REC OUT ..... 150 mV/1.2 kohms  
SUBWOOFER ..... 4.0 V/1.2 kohms

## VIDEO SECTION

- Video Signal Type  
[U.S.A., Canada, China and General models] ..... NTSC  
[Australia and Singapore models] ..... PAL
- Composite Video Signal Level ..... 1 V<sub>p-p</sub>/75 ohms
- S-Video Signal Level  
Y ..... 1 V<sub>p-p</sub>/75 ohms  
C ..... 0.286 V<sub>p-p</sub>/75 ohms
- Component Video Signal Level  
Y ..... 1 V<sub>p-p</sub>/75 ohms  
P<sub>B</sub>/C<sub>B</sub>, P<sub>R</sub>/C<sub>R</sub> ..... 0.7 V<sub>p-p</sub>/75 ohms

- Signal to Noise Ratio ..... 50 dB or more
- Frequency Response (MONITOR OUT)  
Composite, S-Video ..... 5 Hz to 10 MHz, -3 dB  
Component ..... DC to 30 MHz, -3 dB

## FM SECTION

- Tuning Range  
[U.S.A. and Canada models] ..... 87.5 to 107.9 MHz  
[Australia, Singapore, China and General models]  
..... 87.5 to 108.00 MHz
- 50 dB Quieting Sensitivity (IHF, 100% mod.)  
Mono/Stereo ..... 1.6 µV (15.3 dBf) /23 µV (38.5 dBf)
- Alternate Channel Selectivity (400 kHz) ..... 75 dB
- Signal to Noise Ratio (IHF)  
Mono/Stereo ..... 81 dB/75 dB
- Harmonic Distortion (1 kHz)  
Mono/Stereo ..... 0.1%/0.2%
- Stereo Separation (1 kHz) ..... 48 dB
- Frequency Response (20 Hz to 15 kHz) ..... ±1 dB

## AM SECTION

- Tuning Range  
[U.S.A. and Canada models] ..... 530 to 1710 kHz  
[Australia and Singapore models] ..... 531 to 1611 kHz  
[China and General models]  
10 kHz step ..... 530 to 1710 kHz  
9 kHz step ..... 531 to 1611 kHz
- Usable Sensitivity ..... 300 µV/m
- Signal to Noise Ratio ..... 52 dB

## GENERAL

- Power Supply  
[U.S.A. and Canada models] ..... AC 120 V/60 Hz  
[Australia model] ..... AC 240 V/50 Hz  
[Singapore model] ..... AC 230 V/50 Hz  
[China model] ..... AC 220 V/50 Hz  
[General model] ..... AC 110/120/220/240 V, 50/60 Hz
- Power Consumption  
[U.S.A., Australia, Singapore, China and General models]  
..... 260 W  
[Canada model] ..... 260 W/330 VA  
Standby Mode  
[U.S.A. and Canada models] ..... 0.8 W  
[Australia and Singapore models] ..... 0.9 W
- Maximum Power Consumption  
[General model only]  
5-ch, 10% THD ..... 610 W
- AC Outlets (Total 100 W maximum)  
[U.S.A., Canada, Singapore, China and General models]  
..... 2 (SWITCHED)  
[Australia model] ..... 1 (SWITCHED)
- Dimension (W x H x D) ..... 435 x 151 x 390 mm
- Weight ..... 10.5 kg
- Accessories ..... Remote Control  
..... Batteries  
..... AM loop antenna  
..... Indoor FM antenna  
..... Quick Reference Card  
..... Connection Guide

\* Specifications are subject to change without notice.

# GLOSSARY

## ■ Dolby Surround

Dolby Surround uses a four analog channel recording system to reproduce realistic and dynamic sound effects: two left and right main channels (stereo), a center channel for dialog (monaural), and a rear channel for special sound effects (monaural). The rear channel reproduces sound within a narrow frequency range.

Dolby Surround is widely used with nearly all video tapes and laser discs, and in many TV and cable broadcasts as well. The Dolby Pro Logic decoder built into this unit employs a digital signal processing system that automatically stabilizes the volume on each channel to enhance moving sound effects and directionality.

## ■ Dolby Digital

Dolby Digital is a digital surround sound system that gives you completely independent multi-channel audio. With three front channels (left, center and right), and two rear stereo channels, Dolby Digital provides five full-range audio channels. With an additional channel especially for bass effects, called LFE (low frequency effect), the system has a total of 5.1 channels (LFE is counted as 0.1 channel).

Using two-channel stereo for the rear speakers, more accurate moving sound effects and surround sound environment are possible than with Dolby Surround. The wide dynamic range (from maximum to minimum volume) reproduced by the five full-range channels and the precise sound orientation generated using digital sound processing provide listeners with previously unheard of excitement and realism.

With this unit, any sound environment from monaural up to a 5.1-channel configuration can be freely selected for your enjoyment.

## ■ DTS (Digital Theater Systems) Digital Surround

DTS digital surround was developed to replace the analog soundtracks of movies with a six-channel digital sound track, and is now rapidly gaining popularity in movie theaters around the world. Digital Theater Systems Inc. has developed a home theater system so that you can enjoy the depth of sound and natural spatial representation of DTS digital surround in your home. This system is practically distortion-free, clear 6-channel sound (technically, a left, right and center channels, two rear channels, plus an LFE 0.1 channel as a subwoofer, for a total of 5.1 channels).

## ■ LFE 0.1 channel

This channel is for the reproduction of low bass signals. The frequency range for this channel is 20 Hz to 120 Hz. This channel is counted as 0.1 because it only enforces a low frequency range compared to the full-range reproduced by the other 5 channels in a Dolby Digital or DTS 5.1 channel systems.

## ■ CINEMA DSP

Since the Dolby Surround and DTS systems were originally designed for use in movie theaters, their effect is best felt in a theater having many speakers and designed for acoustic effects. Since home conditions, such as room size, wall material, number of speakers, and so on, can differ so widely, it's inevitable that there are differences in the sound heard as well. Based on a wealth of actually measured data, YAMAHA CINEMA DSP uses YAMAHA original sound field technology to combine Dolby Pro Logic, Dolby Digital and DTS systems to provide the visual and audio experience of movie theater in the listening room of your own home.

## ■ SILENT CINEMA

YAMAHA has developed a natural, realistic sound effect DSP algorithm for headphones. Parameters for headphones have been set for each sound field so that accurate representations of all the sound field programs can be enjoyed on headphones.

## ■ Virtual CINEMA DSP

YAMAHA has developed a virtual CINEMA DSP algorithm that allows you to enjoy DSP sound field surround effects even without any rear speakers by using virtual rear speakers.

It is even possible to enjoy virtual CINEMA DSP in a minimum two-speaker system that does not include a center speaker.

## ■ S VIDEO signal

With S VIDEO signal system, the video signal normally transmitted using a pin cable is separated and transmitted as the Y signal for the luminance and the C signal for the chrominance through the S VIDEO cable. Using the S VIDEO jack eliminates video signal transmission loss and allows recording and playback of even more beautiful images.

## ■ Component video signal

With the component video signal system, the video signal is separated into the Y signal for the luminance and the P<sub>B</sub>/C<sub>B</sub> and P<sub>R</sub>/C<sub>R</sub> signals for the chrominance. Color can be reproduced more faithfully with this system because each of these signals is independent. The component signal is also called the “color difference signal” because the luminance signal is subtracted from the color signal. A monitor with component input jacks is required in order to use the component signal for output.

## ■ PCM (Linear PCM)

Linear PCM is a signal format under which an analog audio signal is digitized, recorded and transmitted without using any compression. This is used as a method of recording CDs and DVD audio. The PCM system uses a technique for sampling the size of the analog signal per very small unit of time. Standing for “pulse code modulation”, the analog signal is encoded as pulses and then modulated for recording.

## ■ Sampling frequency and number of quantized bits

When digitizing an analog audio signal, the number of times the signal is sampled per second is called the sampling frequency, while the degree of fineness when converting the sound level into a numeric value is called the number of quantized bits.

The range of rates that can be played back is determined based on the sampling rate, while the dynamic range representing the sound level difference is determined by the number of quantized bits. In principle, the higher the sampling frequency, the wider the range of frequencies that can be played back, and the higher the number of quantized bits, the more finely the sound level can be reproduced.

## ■ I/O assignment (SET MENU)

Although component is normally connected according to jack names shown on the rear panel, this unit includes a function that assigns jacks according to the component being connected. If the component being used differs from the component name shown for this unit’s component video input jacks or digital input/output jacks, it is possible to assign jacks according to the component being connected. This makes it possible to change the jack assignment and effectively connect more component.

# INDEX

<b>A</b>	
Accessories .....	3
AC outlets .....	18
Antennas .....	29
<b>B</b>	
Balance (L/R BALANCE) (SET MENU) .....	38
BGV function .....	25
<b>C</b>	
CBL/SAT position .....	48
CD position .....	46
CINEMA DSP .....	52, 65
Component video .....	66
Connections	
Antennas .....	29
Audio components (MD recorder, CD recorder, CD player and turntable) .....	12
External decoder .....	13
Power supply cords .....	18
Speakers .....	16
Video components (DVD player, VCR and TV/digital TV or cable TV/satellite tuner) .....	14
<b>D</b>	
Delay time .....	41
DISPLAY SET (SET MENU)	
BLUE BACK .....	41
DIMMER .....	41
OSD SHIFT .....	41
DOLBY D. SET (SET MENU)	
D-RANGE .....	40
LFE LEVEL .....	40
Dolby Digital .....	65
Dolby Surround (Dolby Pro Logic) .....	65
DSP program	
CINEMA DSP program .....	51
Hi-Fi DSP program .....	51
DTS .....	65
DTS SET (SET MENU) .....	40
Dust protection cap .....	12
DVD/LD position .....	47
DVD MENU position .....	47
<b>E</b>	
External decoder .....	13
<b>F</b>	
Front panel .....	4
Front panel display .....	9
<b>H</b>	
HP TONE CTRL (SET MENU) .....	39
<b>I</b>	
IMPEDANCE SELECTOR switch .....	18
INPUT MODE (SET MENU) .....	39
Input modes .....	25
I/O ASSIGNMENT (SET MENU) .....	39, 66
<b>L</b>	
LFE .....	40, 65
<b>M</b>	
Manufacturer codes .....	49, i
Memory back-up .....	31, 36, 42, 55
MEMORY GUARD (SET MENU) .....	41
Muting .....	24
<b>P</b>	
PCM .....	66
PHONO jacks .....	12
Playing .....	23
Power supply cords .....	18
Preset stations	
Exchanging preset station .....	33
Tuning in to a preset station .....	32
Presetting stations	
Automatic presetting .....	31
Manual presetting .....	32
<b>R</b>	
Rear panel .....	10
Recording .....	34
Remote control	
Basic operation .....	6
Batteries .....	3
Operation range .....	8
Setup codes .....	49
<b>S</b>	
Sampling frequency .....	24, 66
Selector dial .....	6, 44
SET MENU .....	35
SILENT CINEMA .....	28, 65
Sleep timer .....	43
Sound field .....	54
SP DELAY TIME (SET MENU) .....	41
Speaker	
Output levels (LEVEL mode) .....	36
Output mode (SET MENU) .....	20
Placement .....	11
Output balance (test tone) .....	21
SPEAKER SET (SET MENU)	
CENTER SP .....	36
LFE/BASS OUT .....	38
MAIN LEVEL .....	38
MAIN SP .....	37
REAR L/R SP .....	37
Stereo reproduction .....	28
Subwoofer .....	17
S VIDEO .....	66
<b>T</b>	
TAPE/MD position .....	46
Test tone (TEST DOLBY SUR.) .....	21
TV position .....	48
Tuning	
Automatic tuning .....	30
Manual tuning .....	30
<b>V</b>	
VCR position .....	48
Video jacks .....	14
Virtual CINEMA DSP .....	28, 65

# LIST OF MANUFACTURER CODES LISTES DES CODES FABRICANT

<b>TV</b>		DYNATECH	0881	JVC (VICTOR)	0261, 0281, 0641,	PENNY	0161, 0361, 0521,
A-MARK	1161	ELECTROBAND	0951, 1011		0651, 0661, 0841,		0531, 0621, 0731,
A TANDY	0941	ELECTROHOME	0941		1201, 1211, 1221		0751, 0761, 0781,
ABEX	1151	ELECTRON	0941	KAWASHO	0901		0791, 0861, 0931,
ADMIRA	1141	ELIN	1001	KAYPANI	1021		0941, 1031, 1041,
ADVENTURA	1131	ELTA	0331	KENWOOD	0361, 1031, 1111		1111, 1151, 1161
AIKO	1121	EMERSON	0001, 0021, 0061,	KLOSS	0631, 0721, 1131	PEONY	1561, 1621
AIWA	1481		0071, 0081, 0091,	KTV	0921, 0941, 1011,	PHILCO	0361, 0581, 0591,
AKAI	0331, 1101, 1111		0111, 0811, 0821,		1051, 1111		0601, 0611, 0631,
ALBA	0431		0831, 0841, 0851,	LEYCO	1001		0961, 1031, 1111
ALLERON	1091		0861, 0871, 0901,	LIESENK & TTER	1001	PHILIPS	0101, 0401, 1001
AMBASSADOR	1081		0921, 0941, 0981,	LLOYTRON	0941	PHONOLA	1001
AMSTRAD	0481, 1081		1011, 1031, 1051,	LOEWE	1001	PILOT	0941, 1031, 1111
ANAM	0251, 1041, 1051,	ENVISION	1081, 1091	LOGIK	0991, 1771	PIONEER	0511, 0551, 0871
	1061, 1071	ERRES	0361, 1111	LUXMAN	0351, 0971	PORTLAND	0941, 1031, 1121
ANAM NATIONAL	1041	ETRON	1001	LXI	0101, 0621, 0761,	PRICECLUB	0931
AOC	0361, 1021, 1031,	FERGUSON	0331	MAGNAVOX	0861, 0981	PRISM	0751
	1111, 1161	FINLUX	1001		0101, 0341, 0391,	PROSCAN	0761
ARCHER	1161	FISHER	0171, 0801, 0981		0401, 0411, 0421,	PROTECH	1001
AUDIOSONIC	1001	FORMENTI	0441		0581, 0591, 0601,	PROTON	0501, 0861, 0941,
AUDIOVOX	1051, 1161	FORMONTI	1001		0611, 0631, 0661,		1021, 1161
BAUER	0441	FORTRESS	1141	MAJESTIC	0991	PULSAR	0891
BAUR	1001	FUJITSU	1091	MARANTZ	0101, 0221, 0361,	PULSER	1031
BEIJING	1511, 1551, 1561	FUNAI	1051, 1091, 1501,		1001, 1111	QUASAR	0251, 0751, 1041
BELCOR	1031		1521	MARK	1001	QUELLE	1001
BELL & HOWELL	0981, 0991	FUTURETECH	1051	MATSUI	0271, 0331, 1001	RADIO SHACK	0541, 0941,
BEON	1001	GE	0131, 0161, 0201,	MEDIATOR	1001		1031, 1051,
BRADFORD	1051		0751, 0761, 0771,	MEGATRON	0691, 0861, 1161	RADIOLA	1001
BROCKWOOD	1031		0781, 0791, 0811,	MEI	1011	RCA	0051, 0141, 0151,
BROKSONIC	1161		0861, 1041	M-ELECTRONIC	1001		0181, 0411, 0491,
BUSH	1001	GEC	0271, 1001	MEMOREX	0331, 0571, 0861,		0531, 0761, 0771,
CANDLE	0351, 0361, 0961,	GEMINI	0391		0971, 0981, 0991,		0871, 1031
	0971, 1111, 1131	GENEXXA	0431		1771	REALISTIC	0541, 0861, 0941,
CAPEHART	1021	GIBRALTER	0891, 1031, 1111	METZ	1791, 1831, 1891,		0971, 0981, 1031,
CARVER	0101	GOLDSTAR	0031, 0121, 0351,		1901, 1911, 1921,	RHAPSODY	1011
CATHAY	1001		0411, 0731, 0741,		1931, 1941	R-LINE	1001
CELEBRITY	0951		0861, 0941, 0971,	MGA	0361, 0561, 0571,	RUNCO	0891, 1111
CENTURION	0411		1001, 1031, 1111,		0861, 1031, 1111	SAISHO	0331, 1081
CHANGHONG	1541, 1551, 1561,		1151	MIDLAND	0751, 0761, 0891,	SAMPO	0361, 0941, 1021,
	1621	GOODMANS/TASHIKO			0941, 1151		1111, 1151
CITIZEN	0351, 0361, 0921,		0271, 0661, 1001	MITSUBISHI	0221, 0321, 0561,	SAMSUNG	0331, 0341, 0351,
	0931, 0941, 0961,	GRANADA	1001		0571, 0661, 0861,		0361, 0861, 0931,
	0971, 1111, 1121,	GRUNDIG	1781, 1791, 1801,		1031, 1101, 1381		0941, 0971, 1001,
	1131		1811, 1821, 1831,	MONTGOMERY	1091		1031, 1111, 1151
CLAIRSTONE	1011		1841, 1851, 1861,	MOTOROLA	1041, 1141	SAMSUX	0941
CLARIVOX	1001		1871, 1881	MTC	0351, 0361, 0881,	SANYO	0171, 0231, 0271,
CONCERTO	0351, 0971	GUNPY	1051, 1091		0931, 0971, 1011,		0661, 0801, 0911,
CONROWA	1751	H/K	0721		1031, 1111		0981, 1231, 1251,
CONTEC	0901, 0911, 1011,	HALLMARK	0861	MULTITECH	0881, 1051		1261
	1051	HANSEATIC	1001	NAD	0551, 0621, 0861	SBR	1001
CORANDO	0941	HARVARD	1051, 1061	NEC	0241, 0351, 0361,	SCHEIDER	1001
CRAIG	0251, 1051	HINARI	1001, 1091		0661, 0971, 1031,	SCIMITSU	1031
CROWN	0941, 1051	HITACHI	0181, 0351, 0671,		1111, 1321, 1711	SCOTCH	0861
CURTIS MATHES	0161, 0361,		0681, 0691, 0701,	NECKERMANN	1001	SCOTT	0831, 0861, 0941,
	0931, 0941,		0711, 0871, 0941,	NEI	1001		1031, 1051, 1091
	0981, 1111		0971, 1351	NIKKAI	0271, 0431, 1001,	SEARS	0101, 0161, 0171,
CXC	1051	HYPSON	1001		1151		0351, 0481, 0521,
DAEWOO	0291, 0301, 0331,	IMA	1051	NIKKO	0861, 1111, 1121		0621, 0761, 0801,
	0721, 0941, 1001,	INDIANA	1001	NOVABEAM	0721		0861, 0971, 0981,
	1031, 1121, 1191,	INFINITY REFERENCE		NTC	1121		1091
	1531, 1581, 1591,		0101	ONWA	1051	SHANGHAI	1561, 1681
	1601	INTERFUNK	1001	OPTIMUS	0551	SHARP	0461, 0471, 0541,
DANSAI	1001	ITT	0611	OPTONICA	0541, 1141		0661, 0911, 0941,
DAYTRON	0941, 1031	JANEIL	1131	ORION	0831, 1001		1141, 1241, 1271
DECCA	0271, 1001	JBL	0101	OSAKI	0271, 1151		1031
DIXI	0331, 1001, 1071	JCB	0951	OTTO VERSAND	1001	SHOGUN	0991, 1771
DUMONT	0891, 1031	JENSEN	0311	PANASONIC	0101, 0191, 0251,	SIGNATURE	0581, 0961
		JINXING	1531, 1541, 1551,		0751, 1041, 1311,	SIMPSON	
			1561, 1571, 1621,		1371, 1431	SOLAVOX	1151
			1631, 1641, 1651,	PANDA	1541, 1721	SONOKO	1001
			1691, 1731				



SONTEC	1001	
SONY	0371, 0451, 0661, 0841, 0951, 1281, 1441	
SOUNDESIGN	0861, 0961, 1051, 1091	
SOUNDWAVE	1001	
SPECTRICON	1161	
SQUAREVIEW	0481	
SSS	1031, 1051	
STAR-LITE	1051	
SUPREM	0951	
SUPRE-MACY	1131	
SURPA	0351, 0971	
SYLVANIA	0101, 0361, 0441, 0581, 0591, 0601, 0611, 0631, 0961, 1111	
SYMPHONIC	0481	
SYSLINE	1001	
TANDY	0271, 0431, 1141	
TATUNG	0271, 0881, 1001, 1041, 1161	
TCL	1561, 1631, 1701	
TECHNICS	0751	
TECHWOOD	0351, 0751, 0971	
TEKNIKA	0101, 0351, 0571, 0931, 0941, 0961, 0971, 0991, 1031, 1051, 1091, 1121, 1131, 1771	
TELETECH	0331	
TERA	0501	
THAKRAL	1671	
THORM	1001	
TMK	0351, 0861, 0971, 1081	
TOSHIBA	0381, 0521, 0621, 0661, 0931, 0981, 1301	
TOSONIC	1011	
TOTEVISION	0941	
TRICAL	0911	
UNIVERSAL	0781, 0791	
UNIVERSUM	1001	
VECTOR RESEARCH	0361, 1111	
VESTEL	1001	
VIDEO CONCEPT	1101	
VIDIKRON	0101, 0211	
VIDTECH	0861, 1031	
VIKING	1131	
WARDS	0101, 0361, 0451, 0541, 0581, 0591, 0601, 0611, 0771, 0781, 0791, 0861, 0971, 0991, 1031, 1091, 1111, 1771	
WATSON	1001	
XOGEGO	1611, 1621, 1661, 1741, 1761	
YAMAHA	0361, 1031, 1111	
YOKO	1001	
ZENITH	0011, 0041, 0891, 0991, 1771	
ZONDA	1161	

## CABLE TV

ABC	0256, 0376
ANTRONIX	0136
ARCHER	0136, 0286
BBT	0076
CABLETIME	0166
CABLEVISION	0196
COLOUR VOICE	0306, 0346
COMTRONICS	0216, 0276
EAGLE COMTRONICS	0276
EASTERN	0066
ELECTRICORD	0206
ELECTUS	0266
GE	0116, 0126
GEC CABLE SYSTEM	0196
HAMLIN H5	0676
HAMLIN H6	0666
HAMLIN H6S	0656
HAMLIN H8	0646
HAMLIN H9	0636
JERROLD	0256
JERROLD 400L	0626
JERROLD 450L	0616
JERROLD 550	0606
JERROLD OSD CATV	0596
JERROLD SPRUCER	0436
MAGNAVOX/PHILIPS	0416, 0426
MAMM	0296
MEMOREX	0386
MOVIE TIME	0146, 0206
NORTHCOAST	0016
NSC	0146
OAK	0106
OAK SIGMA 450	0546
OAK SIGMA 550	0536
PANASONIC TZ 120/130	0476
PANASONIC TZ 170/180	0446
PANASONIC TZ140	0466
PANASONIC TZ150/160	0456
PARAGON	0386
PHILIPS	0036, 0216, 0306, 0316, 0326, 0336, 0346
PIONEER	0006, 0086
PIONEER BR50	0846
PIONEER BR60/70/80/81/82	0696
PIONEER BR90	0556
PULSAR	0386
RCA DIGITAL SATELLITE	
SYSTEM	0396, 0406
REALISTIC	0136
REGENCY/EASTERN	0686
RUNCO	0386
SAMSUNG	0276
SCIENTIFIC ATLANTA 175/475	0576
SCIENTIFIC ATLANTA 75	0366, 0586
SCIENTIFIC ATLANTA 8650	0566
SIGNAL	0276
SL MARX	0276
SPECTAVISION	0236
STANDARD COMPONENTS	0186

STARCOM V	0256
STARGATE	0276
SYLVANIA/TEXSCAN	0376, 0496
TEKNIKA	0176
TELESERVICE	0056
TELEVIEW	0276
TEXSCAN	0186, 0376
TFC	0026
TOCOM	0226, 0356
TOCOM 5503A	0526
TOCOM 5503VIP/5507	0516
TOCOM TC56	0506
TOSHIBA	0386
TUDI	0046
UNIKA	0136
UNIVERSAL	0136, 0156, 0206, 0286
VIDEOWAY	0096
VIEWSTAR	0216
ZENITH	0246, 0386, 0486

## SATELLITE TUNER

ALPHA STAR	0826
CHAPARRAL	0756
ECHOSTAR	0836
GENERAL INSTRUMENT	0776, 0876
HTS	0836
HUGHES NETWORK SYSTEMS	0816
JERROLD	0776, 0786
PANASONIC	0806
PRIMESTAR	0776, 0786
RCA	0766
SONY	0796

## (DSS)

HITACHI	0856
MAGNAVOX	0886
MEMOREX	0886
PHILIPS	0886
STAR CHOICE	0876
TOSHIBA	0866
UNIDEN	0886

---

<b>VCR</b>	
A TANDY	0902
ADVENTURA	0992
AIKO	0982
AIWA	0992
AKAI	0262, 0942, 0952, 0962, 0972
AMERICAN HIGH	0932
AMSTRAD	0992
ASA	0002, 0912
ASHA	0922
AUDIO DYNAMICS	0202
AUDIOVOX	0912
BEAUMARK	0922
BELL & HOWELL	0902
BLAUPUNKT	0412
BROKSONIC	0872, 0882, 0892
BUSH	0852
CALIX	0912
CANON	0862, 0932
CCE	0852, 0982
CITIZEN	0912, 0982
COLT	0852
CRAIG	0832, 0842, 0852, 0912, 0922
CURTIS MATHES	0662, 0822, 0932
CYBERNEX	0922

DAEWOO	0802, 0812, 0982
DBX	0202
DYNATECH	0472, 0992
ELECTROHOME	0912
ELECTROPHONIC	0912
EMEREX	0792
EMERSON	0072, 0132, 0142, 0152, 0162, 0172, 0182, 0192, 0212, 0702, 0712, 0722, 0732, 0742, 0752, 0762, 0772, 0782, 0872, 0882, 0892, 0912, 0952, 0992, 1072
FINLUX	0002, 0992
FISHER	0682, 0692, 0842, 0902
FUJI	0672, 0932
FUNAI	0992
GARRARD	0992
GE	0662, 0822, 0932
GO VIDEO	0642, 0652
GOLDSTAR	0082, 0632, 0912
GOODMANS	0402
GRADIENTE	0992
GRANDA	0612, 0902
GRUNDIG	0002
H/K	1082
HARLEY DAVIDSON	0992
HARMAN/KARDON	0632, 1082
HARWOOD	0752, 0852
HEADQUARTER	0612
HI-Q	0842
HINARI	0852
HITACHI	0102, 0562, 0572, 0582, 0592, 0602, 0992
ITT	0942
JVC (VICTOR)	0202, 0522, 0532, 0542, 0552
KENWOOD	0202, 0542, 0612, 0632, 0902
KLH	0852
KODAK	0912, 0932
LLOYD	0992
LOGIK	0852
LUXOR	0942
LXI	0922, 0912
MAGNAVOX	0002, 0482, 0492, 0502, 0512, 0932
MAGNIN	0922
MARANTZ	0002, 0202, 0402, 0632, 0932
MARTA	0912
MATSUSHITA	0932
MATSUI	0722
MEI	0222, 0932
MEMOREX	0232, 0242, 0472, 0512, 0612, 0842, 0902, 0912, 0922, 0932, 0992
MGA	0762, 0952
MGA TECHNOLOGY	0922
MINOLTA	0592, 0602
MITSUBISHI	0452, 0462, 0542, 0762, 0952, 1082
MOTOROLA	0472, 0932
MTC	0922, 0992
MULTITECH	0852, 0992
NAD	0442

NEC	0122, 0202, 0292, 0422, 0432, 0542, 0632	TEKNIKA	0322, 0912, 0932, 0992	<b>CD PLAYER</b>	REALISTIC	0205, 0225, 0235, 0325, 0555, 0845
NIKKO	0912	TELEFUNKEN	0252	ACOUSTIC RESEARCH	REVOX	1175
NOBLEX	0922	TMK	0212, 0732, 0772, 0922	ADC	ROTEL	0215
OLYMPUS	0412, 0932	TOSHIBA	0062, 0302, 0342, 0622, 0682, 0712, 0762	ADCOM	SABA TELECOMMANDER (E)	0505
OPTIMUS	0442, 0472, 0912	TOTEVISION	0912, 0922	ADS	SAE	0215
OPTONICA	0402	UNITECH	0922	AIWA	SAMSUNG	1285
ORION	0212, 0722, 0742, 0772	VECTOR RESEARCH	0202, 0432, 0632	AKAI	SANSUI	0215, 0625, 0975, 1025, 1105
OSAKI	0912	VIDEO CONCEPTS	0202, 0432, 0632, 0952	ALPINE	SANYO	0145, 0555, 0635, 0765
PANASONIC	0012, 0052, 0092, 0222, 0372, 0382, 0392, 0412, 0932	WARDS	0322, 0402, 0472, 0482, 0602, 0712, 0842, 0852, 0922, 0932, 0992	AUDIO-TECHNICA	SCOTT	0325, 1105
PENNY	0202, 0432, 0602, 0632, 0692, 0912, 0922, 0932	YAMAHA	0202, 0632	BSR	SEARS	0345
PENTAX	0592, 0602	ZENITH	0042, 0362, 0512, 0672	CALIFORNIA AUDIO LAB	SHARP	0235, 0665, 0895, 1065, 1075
PERDIO	0992			0055	SHERWOOD	0115, 0235, 0395, 0475
PHILCO	0002, 0932			CAPETRONIC	SIEMENS GARRARD	1245
PHILIPS	0002, 0282, 0402, 0492, 0932			CARRERA	SIGNATURE	0175
PILOT	0912			CARVER	SONTEC	1165
PIONEER	0442, 0542			CASIO	SONY	0065, 0565, 0865, 1145
PROSCAN	1002, 1012, 1022, 1032, 1042, 1052, 1062			CROWN	STARON	1235
PULSAR	0512			CURTIS MATHS	STS	0025
QUARTER	0612			DENON	SYLVANIA	0215
QUARTZ	0272, 0612			DEUAL (E)	SYMPHONIC	0335
QUASAR	0382, 0392, 0932			DYNAMIC BASS (H)	TANDY	0305
RADIO SHACK	0912, 0992			0555	TANGBERG	1195
RADIX	0912			EMERSON	TEAC	0235, 0335, 0385, 0525, 0795, 0835, 1355
RANDEX	0912			EROICA	TECHNICS	0055, 0605, 1095
RCA	0112, 0382, 0392, 0482, 0592, 0602, 0662, 0822, 0942			FISHER	TECHWOOD	1325
REALISTIC	0402, 0472, 0612, 0682, 0842, 0902, 0912, 0922, 0932, 0992			GARRARD	TELEFUNKEN (E)	0505
RICOH	0352, 0362			GENEXXA	THOMSON (E)	0505
SAISHO	0212, 0582, 0722, 0732, 0742, 0772			GOLDSTAR	TOSHIBA	0035, 0685
SALORA	0612, 0762			H/K	VECTOR RESEARCH	0065, 1135
SAMSUNG	0212, 0312, 0922, 0962			0105, 0175, 0465, 0995	WARDS	0175
SANKY	0472, 0512			HITACHI	YAMAHA	0005, 0015, 0085, 0415, 0545, 0575, 1065
SANSUI	0292, 0542, 0832			INKEL		
SANYO	0242, 0612, 0842, 0902, 0922			JVC (VICTOR)		
SBR	0002, 0282			KENWOOD		
SCHEIDER	0852			0045, 0095, 0405, 0585, 0725, 0735, 0745, 0755, 0895		
SCOTT	0342, 0712, 0762, 0872, 0882, 0892			KYOCERA		
SEARS	0302, 0592, 0602, 0612, 0682, 0692, 0842, 0902, 0912, 0932			LUXMAN		
SHARP	0402, 0472			0075, 0425, 0675, 0705, 0715, 0985		
SHINTOM	0852			MAGNAVOX		
SHOGUN	0922			0165, 0215, 0645, 0955		
SINGER	0852			MARANTZ		
SONY	0032, 0332, 0352, 0362, 0672, 0792, 0932			0215, 0235, 0375, 0785, 1345		
STS	0602			MCINTOSH		
SUNPAK	0352			MCS		
SYLVANIA	0002, 0492, 0502, 0762, 0932, 0992			0355, 1085		
SYMPHONIC	0992			0905, 1315		
TANDY	0992			MEMOREX		
TASHIKO	0712, 0992			0205, 0225, 0235, 0305, 0325, 1105		
TEAC	0992			MGA		
TECHNICS	0932			0135		
				MISSION		
				0215		
				0135, 0445		
				MITSUBISHI		
				1255		
				MTC		
				0035, 0615, 0685, 0695		
				NAD		
				0695		
				NAKAMICHI		
				0125, 0435, 0515		
				NEC		
				0255, 0905, 0965		
				NIKKO		
				0545, 1005		
				ONKYO		
				0155, 0455, 0495, 0805, 1155		
				OPTIMUS		
				0225, 0245, 0555, 0595, 0845, 0855, 0865, 0895, 0935		
				PANASONIC		
				0055, 0825, 1095, 1125		
				PENNY		
				0905		
				PHILIPS		
				0165, 0215		
				PIONEER		
				0305, 0935, 1045		
				PROTON		
				0215, 1185		
				QUASAR		
				0055		
				RCA		
				0205, 0915, 1115		

### DVD PLAYER

AKAI	0108
DENON	0368
HITACHI	0388
JVC	0168, 0348
KENWOOD	0288
MAGNAVOX	0248
MITSUBISHI	0268
ONKYO	0128, 0248
PANASONIC	0048
PHILIPS	0188, 0248
PIONEER	0208, 0228
PROSCAN	0308
RCA	0308
SAMSUNG	0148
SHARP	0068
SONY	0028
TECHNICS	0048
THOMSON	0328
TOSHIBA	0088, 0248
YAMAHA	0008, 0048, 0188, 0248
ZENITH	0248

### LD PLAYER

AIWA	0157
DENON	0147
DISCO VISION	0017
FUNAI	0157
HITACHI (E)	0017
KENWOOD	0087, 0107
MAGNAVOX	0027
MARANTZ	0027
MITSUBISHI	0137
NAD	0137
PANASONIC	0077, 0177
PHILIPS	0027
PIONEER	0017, 0037, 0137
RCA	0167
REALISTIC	0157
SHARP	0127
SONY	0047, 0057, 0117
VICTOR	0097
YAMAHA	0007, 0067

### CD RECORDER/CD-RW

HITACHI	0474
JVC	0504
MARANTZ	0484, 0494
PHILIPS	0444
PIONEER	0454, 0464
YAMAHA	0414

### MD RECORDER

KENWOOD	0384
PIONEER	0424
SHARP	0434
SONY	0394
YAMAHA	0024, 0394, 0404

---

## **TAPE DECK**

AIWA	0094, 0214, 0224
AKAI	0184
CARVER	0094
DENON	0304
FISHER	0144
GARRARD	0194, 0204
JVC (VICTOR)	0274, 0284, 0294
KENWOOD	0124, 0134, 0154, 0234, 0244, 0264
MAGNAVOX	0094
MARANTZ	0094, 0344
MITSUBISHI	0184
OPTIMUS	0034, 0064, 0204, 0334
ONKYO	0364, 0374
PHILIPS	0094
PIONEER	0034, 0044, 0064
REVOX	0354
SANSUI	0094, 0344
SHARP	0264
SHERWOOD	0334
SONY	0054, 0084, 0324
TEAC	0194, 0254
TECHNICS	0074, 0314
WARDS	0034
YAMAHA	0004, 0014, 0104, 0114, 0164, 0174, 0264



---

**YAMAHA ELECTRONICS CORPORATION, USA** 6660 ORANGETHORPE AVE., BUENA PARK, CALIF. 90620, U.S.A.  
**YAMAHA CANADA MUSIC LTD.** 135 MILNER AVE., SCARBOROUGH, ONTARIO M1S 3R1, CANADA  
**YAMAHA ELECTRONIK EUROPA G.m.b.H.** SIEMENSSTR. 22-34, 25462 RELLINGEN BEI HAMBURG, F.R. OF GERMANY  
**YAMAHA ELECTRONIQUE FRANCE S.A.** RUE AMBROISE CROIZAT BP70 CROISSY-BEAUBOURG 77312 MARNE-LA-VALLEE CEDEX02, FRANCE  
**YAMAHA ELECTRONICS (UK) LTD.** YAMAHA HOUSE, 200 RICKMANSWORTH ROAD WATFORD, HERTS WD1 7JS, ENGLAND  
**YAMAHA SCANDINAVIA A.B.** J A WETTERGRENS GATA 1, BOX 30053, 400 43 VÄSTRA FRÖLUNDA, SWEDEN  
**YAMAHA MUSIC AUSTRALIA PTY, LTD.** 17-33 MARKET ST., SOUTH MELBOURNE, 3205 VIC., AUSTRALIA

**YAMAHA CORPORATION**  
Printed in Malaysia ID V722860

# Connection Guide (when listening to a digital 5.1-channel source)

DVD player

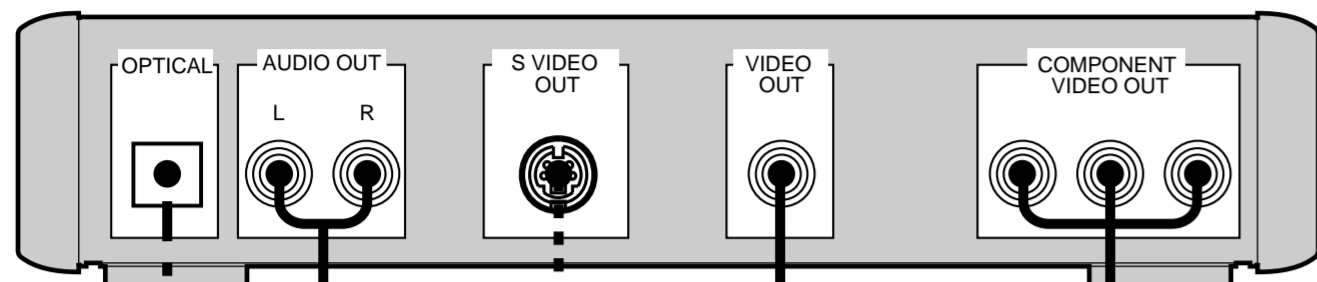

Main speakers A

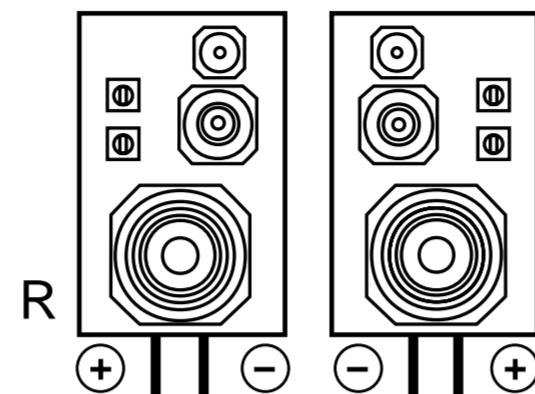

Main speakers B

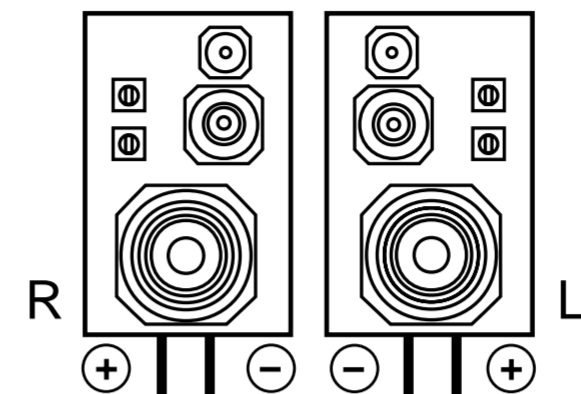

OPTICAL OUT  
AUDIO OUT  
S VIDEO OUT  
VIDEO OUT  
COMPONENT VIDEO OUT

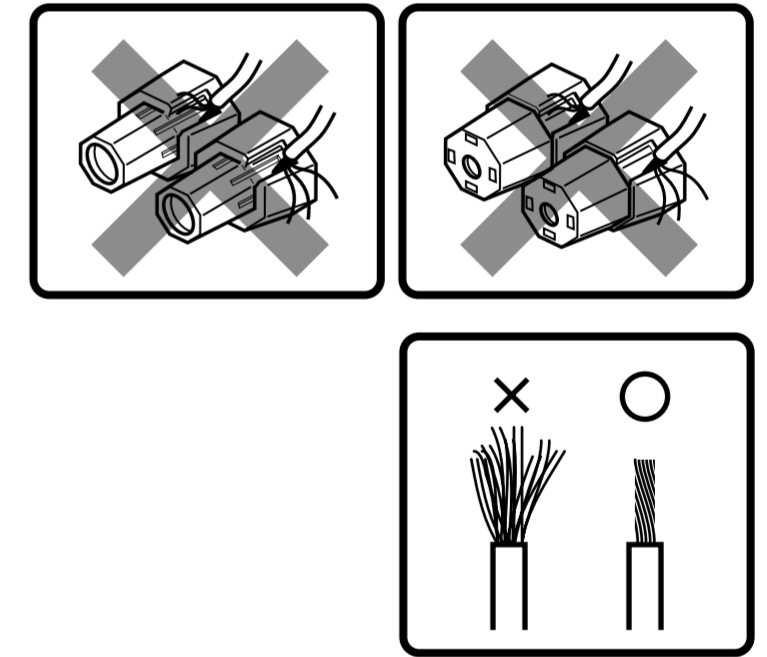
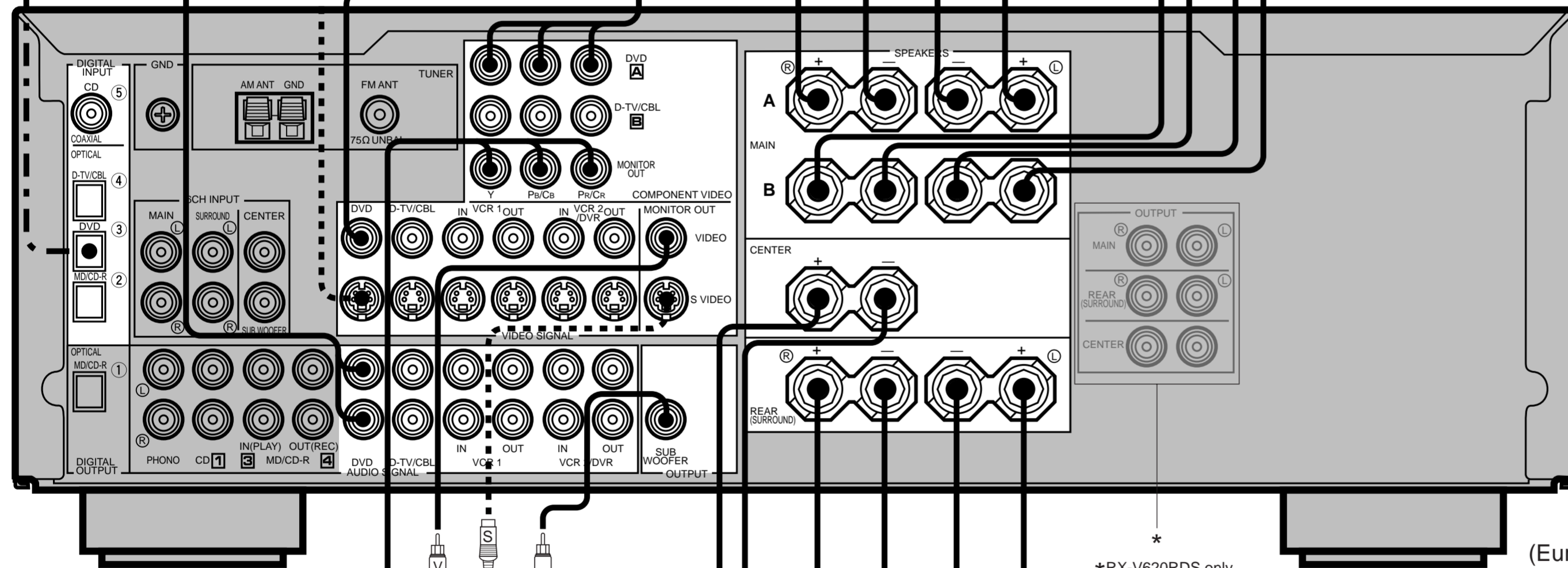

COMPONENT VIDEO IN  
VIDEO IN  
S VIDEO IN

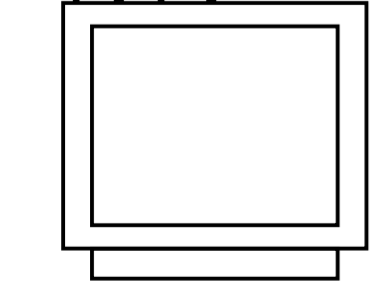

Video Monitor

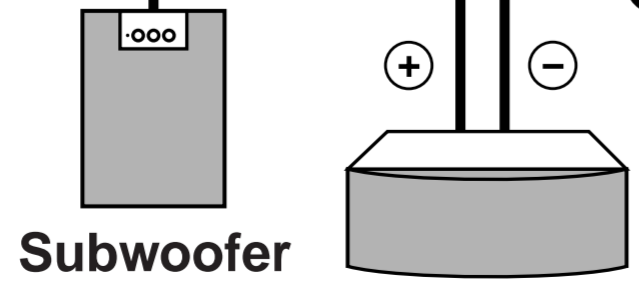

Subwoofer system

Center speaker

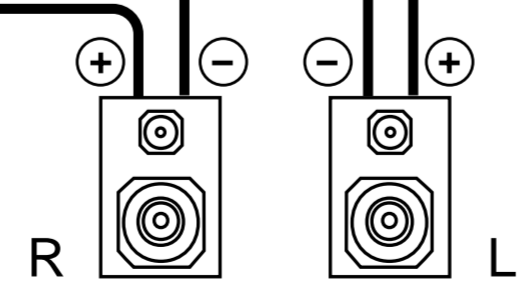

Rear speakers

\*RX-V620RDS only (Europe model)

- Analog signal
- S Video signal
- Video signal
- Optical signal
- Signal flow

# Quick Reference Card

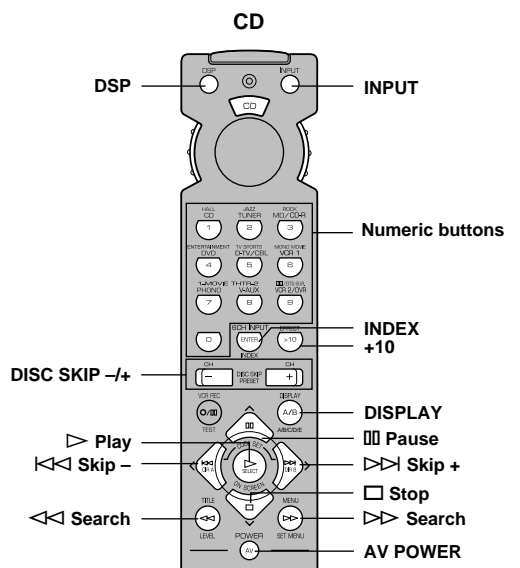
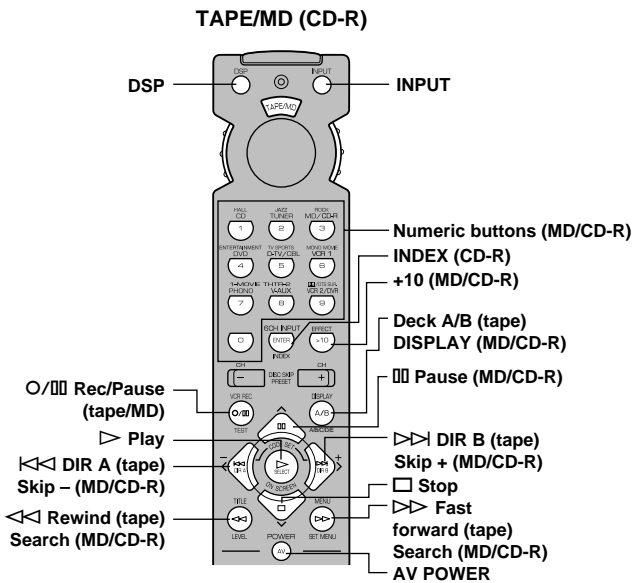
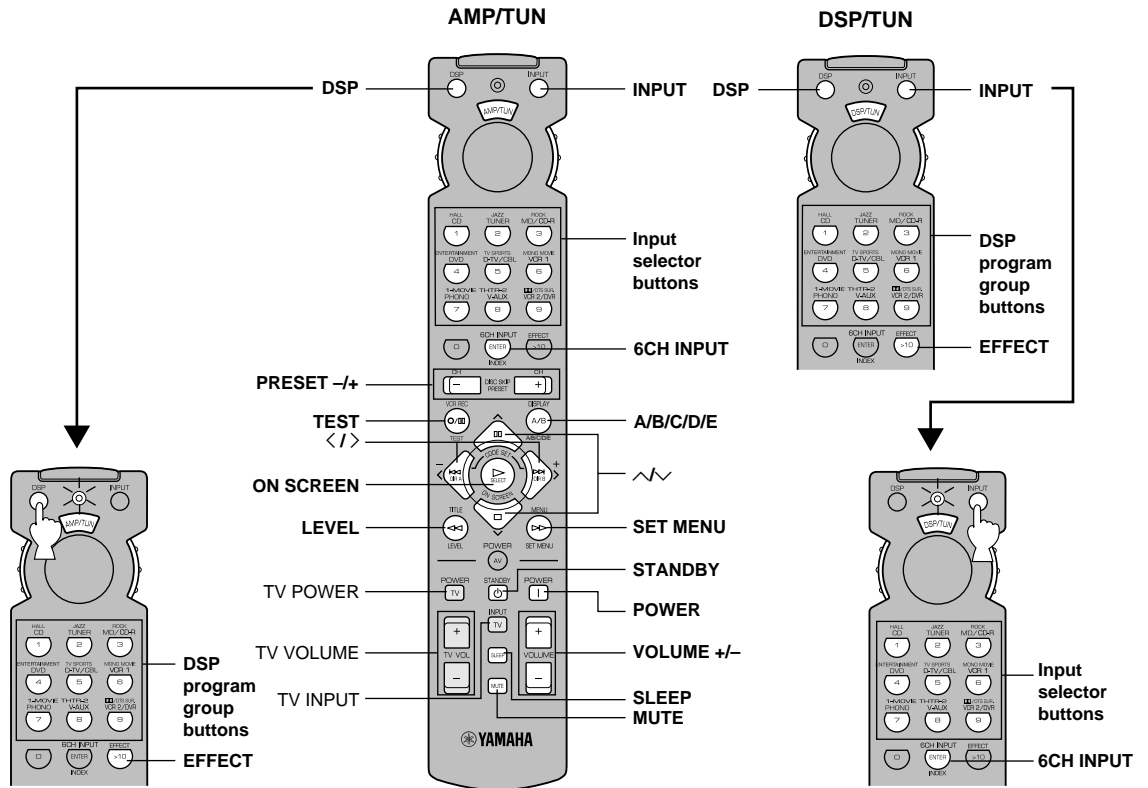

# Quick Reference Card

## DVD/LD

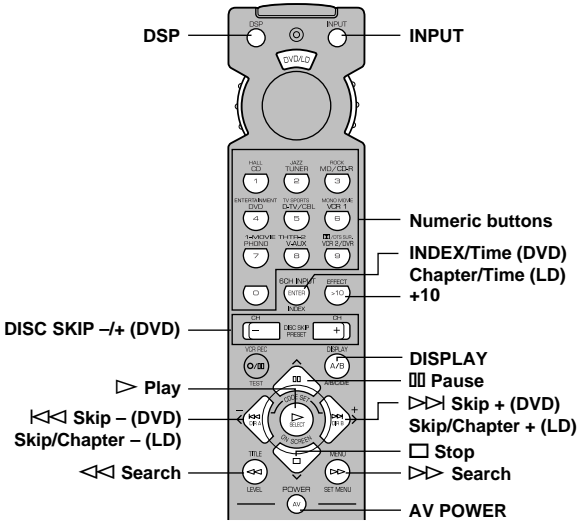

## DVD MENU

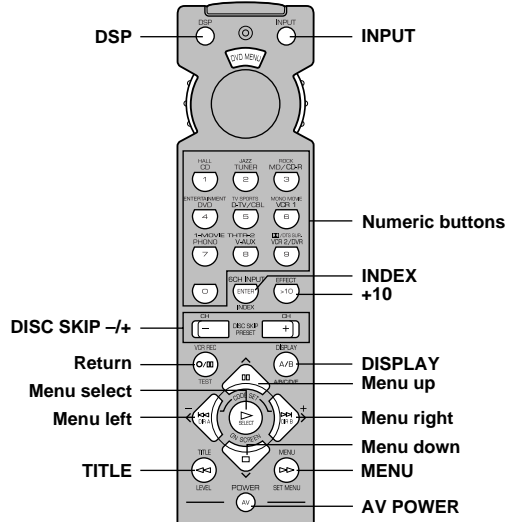

## VCR

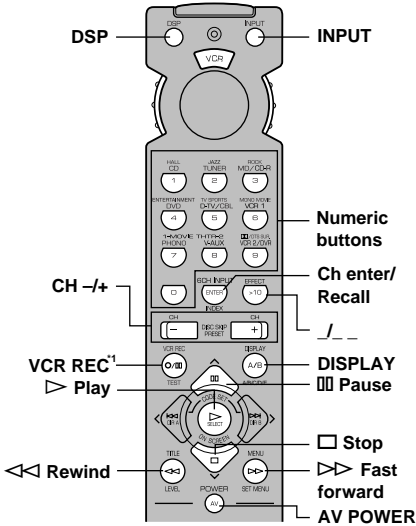

## TV

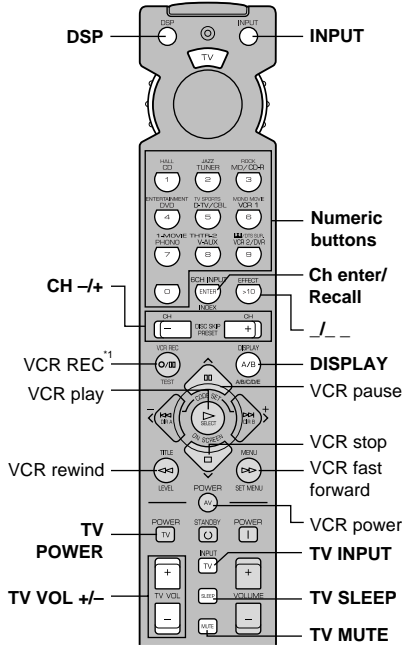

## CBL/SAT

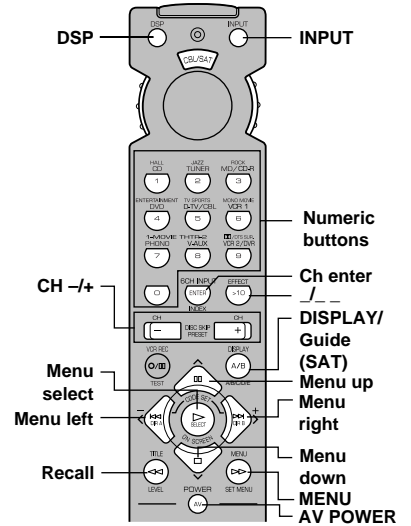

\*1 Press this button twice to start recording.  
Appuyer deux fois sur cette touche pour commencer l'enregistrement.  
Drücken Sie diese Taste zweimal, um die Aufnahme zu starten.  
Tryck två gånger på den här knappen för att börja spela in.

Premere due volte questo tasto per iniziare la registrazione.  
Presione dos veces este botón para empezar a grabar.  
Druk tweemaal op deze toets om met opnemen te beginnen.  
按此按钮两次即可开始录像。